

SAMSUNG

FCU

Technical Data Book

**Fan Coil Unit for Europe
(Water, 50Hz)**



Model : AG0**MN1DEH (1Way Cassette), AG**MN4DKH (4Way Cassette) AG**MN4PKH (360 Cassette)

History

Version	Modification	Date	Remark
Ver.1.0	Release FCU Fan Coil Unit for EU TDB (Water, 50Hz)	17.06.13	
Ver.1.1	Revise some errors in the line up page.	17.07.25	
Ver.1.2	Revised the pannel demensional drawing of 1Way CST (P.18).	17.08.18	
Ver.1.3	Updated the Appendix Page(Capacity Table)	18.06.08	
Ver.1.4	Updated the Heating Capacity Table	19.02.27	
Ver.1.5	Modified the Shipping Weight (AG***MN4PKH/EU)	19.09.18	
Ver.1.6	Updated the Summary Table page	20.10.20	

Nomenclature

Indoor Unit

Model Name

AG	026	M	N	1	D	E	H	/	EU
(1)	(2)	(3)	(4)	(5)	(6)	(7)	(8)		Buyer

(1) Classification

AG	Chiller / FAN COIL UNIT
-----------	-------------------------

(2) Capacity

	X 1/10 kW (3 digits)
--	----------------------

(3) Version

H	2014
J	2015
K	2016
M	2017

(4) Product Type

N	Indoor Unit
X	Outdoor Unit

(5) Product Notation

1	1 Way Cassette
N	4 Way Cassette (600x600)
4	4 Way Cassette, 360 Cassette
L	LSP Duct
M	MSP Duct
C	Ceiling
J	Console
Q	RAC (with EEV)
T	RAC (without EEV)
A	A3050 (Wall Mounted)

(6) Feature

F	Flagship
S	Standard
D	Deluxe
P	Premium

(7) Rating Voltage

E	1Φ, 220~240V, 50Hz
K	1Φ, 220~240V, 50/60Hz
C	1Φ, 208~230V, 60Hz

(8) Mode

H	Heat Pump
----------	-----------

Features & Benefits

360 Cassette

Comfortably cool, not cold

A bladeless design softly disperses cool air across the room, making you comfortably cool without feeling a cold draft**. With no blades to block the air flow, it also expels 25% more air* and spreads it farther.



* Within a 5m radius, no cold draft between 0~1.5m in height (with 14.0kw).

Circular to perfectly fit in everywhere

Its innovative circular design can match a multitude of interior designs, so it perfectly fits in everywhere. Its minimalist modern styling creates a sophisticated look and its circular shape stands out beautifully.

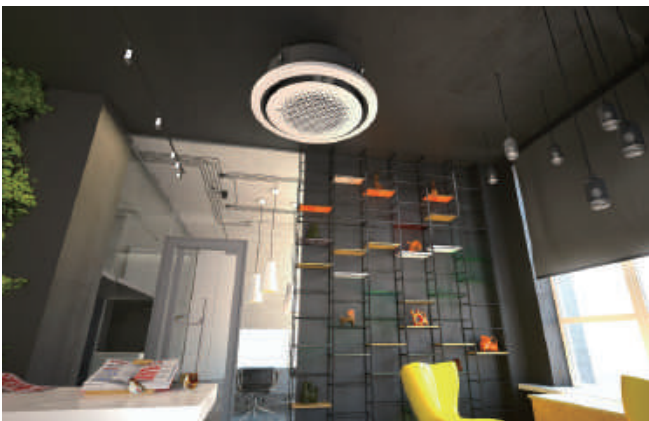

Spreads more air in more ways

An innovative Booster Fan enables cool air to be expelled at much lower angles. It creates a low pressure area around the outlet, so that cool air comes out parallel to the ceiling and disperses across a wider area.

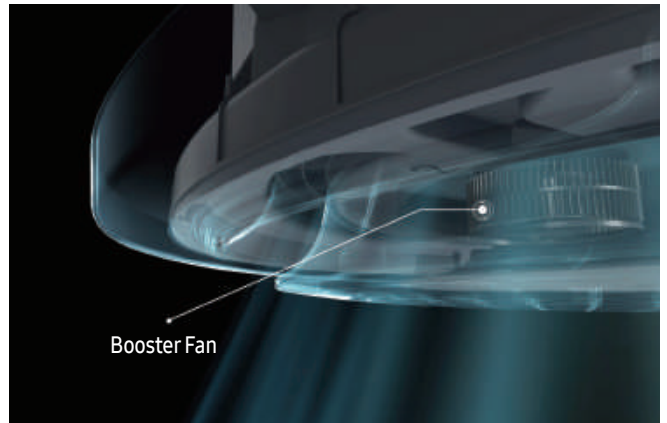

All round simpler & intuitive control

Intuitively control its performance and see where the air is going. The Wireless Remote Controller's* Jog shuttle and button offer a fun way to adjust the air flow and a Circular LED Display shows its direction.

* Optional.



Features & Benefits

4Way Cassette

Complement any interior with a sleek, lightweight design

The new Samsung 4Way Cassette indoor air conditioner comes in a choice of patterns with a simple panel to better match the interior design. Its uniquely lightweight frame makes installation easy, while clever blade construction keeps the unit clean for a tidy appearance.



Neat and clean design

The indoor 4Way Cassette boasts a smart design that promotes a neat and clean look. The completely hermetic blade structure keeps the indoor unit clean by preventing dust or other foreign substances from entering it. The internal parts of the indoor unit are also out of sight when the blade is shut, thus improving the unit's appearance.

Lightweight build

The Samsung 4Way Cassette indoor unit is now lighter in weight at 18 kg. It is one of the lightest indoor units in the industry, about 40 percent lighter than conventional products.

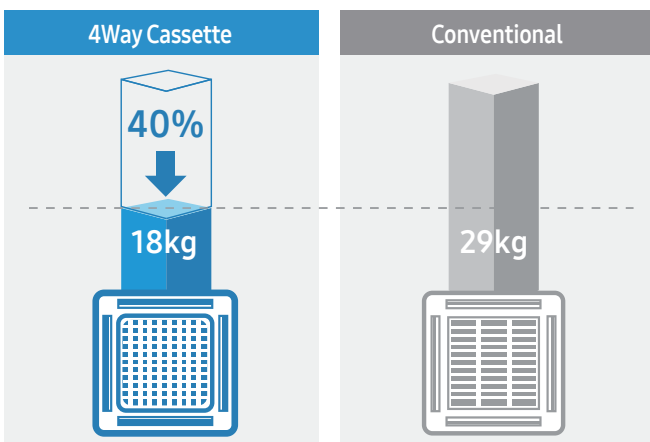

*Based on 10kW

Achieve peak performance with optimal airflow and superior control

Integrating the most advanced technologies, Samsung 4Way Cassette delivers easy, efficient comfort with specialized blade control, adjustable operation and powerful airflow. And optional Virus Doctor extends the unit's efficiency with air sanitation technology for a healthier atmosphere.

Individual blade control

Samsung 4Way Cassette features a remote controller that enables users to manipulate the angles of the fan blades for more efficient cooling. With the remote controller, users can individually set the opening angles of the four blades at the same angle or different angles within a 32° - 65° range to create just the right atmosphere.



Optimal airflow for high ceilings

Using only the remote controller, operators can achieve optimum fan speed for high ceilings without adjusting the dual inline package (DIP) switch on the printed circuit board (PCB). The fan speed adjustment function evenly distributes cool and warm air throughout spaces with high ceilings of up to 3.5 m. And the high ceiling mode delivers even more powerful airflow throughout the interior space, enlarging the airflow coverage area for heights of up to 4.6 m.



*Based on 10kW

Features & Benefits

1Way Cassette

Enhance any décor with refined elegance and comfort

Sim 1Way Cassette features a simple and refined design. The clean lines and simple display design make this a modern classic, which looks great with any interior.

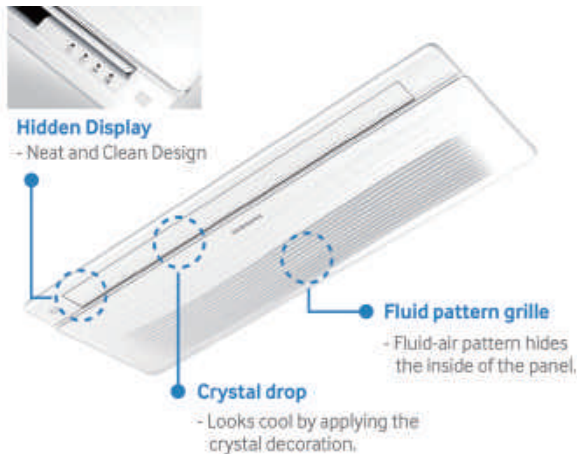

Enhance any environment with the best of air conditioning performance and sleek style

Samsung Slim 1Way Cassette is an optimized air solution that suits both practical and aesthetic needs with its simple design and efficient cooling operation. The slim, rounded design of the Slim 1Way Cassette unit creates a near-seamless ceiling for a clean ambiance. And its progressive design, including superior blade technology, delivers high performance and easy management without compromise.

Visually appealing panel

Slim 1Way Cassette projects refined simplicity. The clean lines and simple display design make this a modern classic, which looks great with any interior.

Ease installation and maintenance with a slim and compact design

At a height of only 135mm, the Slim 1Way Cassette is the world's thinnest indoor air cooling unit. The compact, lightweight design makes installation and maintenance in your space easier than ever. These high-performing units are so discreet that they can easily blend into interiors of all types and styles.

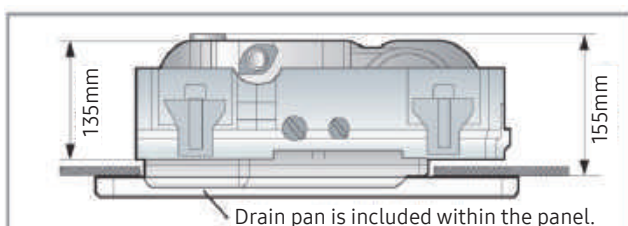

NOTE

- Make sure that there is enough installation space. Allow at least 170mm for the installation.



Air reaches every corner of the room.

Blade angle can move from 40°C - 80°C to reach every corner of the room.



Drip-free operation

The check valve on the drain pump prevents drained water from flowing backward into the drain pan. This minimizes the drain pan's water level, eliminating the hassles of water stagnation or overflowing drain water dripping into the interior.

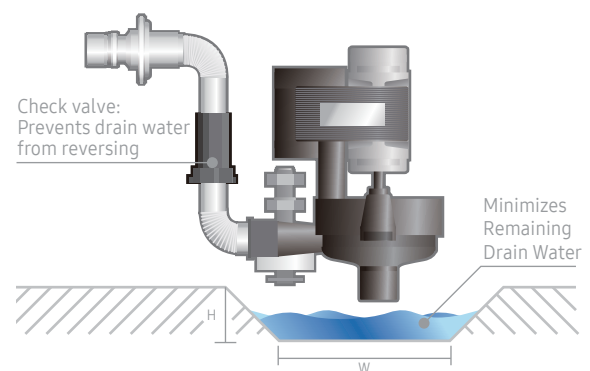



Contents

1. Line-up	8
2. Specification	9
3. Summary Table	15
4. Dimensional Drawing	17
5. Center of Gravity	22
6. Electrical Wiring Diagram	24
7. Sound Data	27
8. Temperature and Airflow Distribution	33
9. Piping Diagram	39
10. Installation	40
※ Appendix : Capacity Table	51

1. Line-up

Fan Coil Unit

(kW)

Model Type	Image	2.6	3.0	4.2	6	7.2	9	10.0
1Way Cassette		•	•	•				
4Way Cassette					•	•	•	•
360 Cassette					•	•	•	•

2. Specification

1Way Cassette

Type				1Way Cassette	1Way Cassette	1Way Cassette
Model				AG026MN1DEH/EU	AG032MN1DEH/EU	AG042MN1DEH/EU
Power Supply			Φ, V, Hz	1, 220~240, 50	1, 220~240, 50	1, 220~240, 50
Mode				-	HP	HP
Performance	Capacity (Nominal)	Cooling	kW	2.60	3.00	4.15
		Heating		2.90	3.35	5.00
Power	Power Input (Nominal)	Cooling	W	47.0	50.0	55.0
		Heating		47.0	50.0	55.0
	Current Input (Nominal)	Cooling	A	0.24	0.26	0.29
		Heating		0.24	0.26	0.29
Heat exchanger	Type		-	Fin & Tube	Fin & Tube	Fin & Tube
	Material	Fin	-	Al	Al	Al
		Tube	-	Cu	Cu	Cu
	Fin Treatment		-	Green Hydrophile	Green Hydrophile	Green Hydrophile
Fan	Type		-	Cross Flow Fan	Cross Flow Fan	Cross Flow Fan
	Quantity		EA	1	1	1
	Air Flow Rate	H/M/L	CMM	6.8/5.8/4.9	7.8/6.8/4.9	14.6/12.6/10.7
			l/s	-	-	-
Fan Motor	Type		-	AC	AC	BLDC
	Output x n		W	12 x 1	12 x 1	54 x 1
Water	Water Flow Rate	Cooling	LPM	7.5	9.6	11.9
	Water Flow Rate	Heating	LPM	8.4	9.7	14.4
	Loss of Head	Cooling	kPa	23	34.5	45
	Loss of Head	Heating	kPa	28	35.8	64.6
Piping Connections	Liquid Pipe (IN)		Type	PF MALE	PF MALE	PF MALE
			ø, mm (inch)	20A (3/4")	20A (3/4")	20A (3/4")
	Liquid Pipe (OUT)		Type	PF MALE	PF MALE	PF MALE
			ø, mm (inch)	20A (3/4")	20A (3/4")	20A (3/4")
	Heat insulation		-	Both inlet/outlet pipes	Both inlet/outlet pipes	Both inlet/outlet pipes
Drain Pipe		Φ,mm	VP20 (OD 26, ID 20)	VP20 (OD 26, ID 20)	VP25 (OD 32, ID 25)	
Wiring connections	Communication	Min.	mm ²	0.75	0.75	0.75
		Remark	-	F1, F2	F1, F2	F1, F2
Sound	Sound Pressure	High / Mid / Low	dB(A)	32/30/28	37/33/28	40/37/33
	Sound Power	Cooling		49	52	58
Dimensions	Net Weight		kg	10.5	10.5	14.0
	Shipping Weight		kg	13.5	13.5	17.5
	Net Dimensions (W×H×D)		mm	970 × 135 × 410	970 × 135 × 410	1,200 × 138 × 450
	Shipping Dimensions (W×H×D)		mm	1,173 × 231 × 487	1,173 × 231 × 487	1,435 × 224 × 525
Casing	Material		-	Plastic	Plastic	Plastic
Panel	Panel model		-	PC1NUSMAN	PC1NUSMAN	PC1BWSMAN
	Panel Net Weight		kg	3.1	3.1	6.6
	Shipping Weight		kg	6.4	6.4	8.3
	Net Dimensions (W×H×D)		mm	1,198 × 25 × 500	1,198 × 25 × 500	1,410 × 23 × 500
	Shipping Dimensions (W×H×D)		mm	1,262 × 144 × 542	1,262 × 144 × 542	1,473 × 124 × 568
Additional Accessories	Drain pump	Type	-	Built In	Built In	Built In
		Max. lifting Height / Displacement	mm / (cc/min)	750 / 400	750 / 400	750 / 400
	Filter		-	Microfibrous filter	Microfibrous filter	Microfibrous filter

2. Specification

1Way Cassette

 NOTE

- Cooling : Indoor temperature 27°C DB, 19°C WB / Water In/Out temperature 7°C, 12°C
Heating : Indoor temperature 20°C DB, 15°C WB / Water In/Out temperature 45°C, 40°C
- Sound level was acquired in an anechoic room. Thus actual noise level may be different depending on the installation conditions.
- Specifications may be subject to change without prior notice.
- Select wire size based on the value of MCA

2. Specification

4Way Cassette

Type				4Way Cassette	4Way Cassette	4Way Cassette	4Way Cassette
Model				AG060MN4DKH/EU	AG072MN4DKH/EU	AG090MN4DKH/EU	AG105MN4DKH/EU
Power Supply			Φ, V, Hz	1, 220~240, 50/60	1, 220~240, 50/60	1, 220~240, 50/60	1, 220~240, 50/60
Mode			-	HP	HP	HP	HP
Performance	Capacity (Nominal)	Cooling	kW	6.00	7.20	9.00	10.00
		Heating		7.30	8.50	10.00	10.70
Power	Power Input (Nominal)	Cooling	W	50.0	73.0	82.0	99.0
		Heating		50.0	73.0	82.0	99.0
	Current Input (Nominal)	Cooling	A	0.37	0.50	0.58	0.79
		Heating		0.37	0.50	0.58	0.79
Heat exchanger	Type		-	Fin & Tube	Fin & Tube	Fin & Tube	Fin & Tube
	Material	Fin	-	Al	Al	Al	Al
		Tube	-	Cu	Cu	Cu	Cu
	Fin Treatment		-	Green Hydrophile	Green Hydrophile	Green Hydrophile	Green Hydrophile
Fan	Type		-	Turbo Fan	Turbo Fan	Turbo Fan	Turbo Fan
	Quantity		EA	1	1	1	1
	Air Flow Rate	H/M/L	CMM	18.9/16.5/13.6	21.3/18.2/13.6	23.3/21.3/19.4	30.1/26.2/19.4
			l/s	-	-	-	-
Fan Motor	Type		-	BLDC	BLDC	BLDC	BLDC
	Output x n		W	65 x 1	65 x 1	65 x 1	97 x 1
Water	Water Flow Rate	Cooling	LPM	17.5	20.8	26.0	28.9
	Water Flow Rate	Heating	LPM	21.1	24.5	28.9	30.9
	Loss of Head	Cooling	kPa	27	36	46.8	56.3
	Loss of Head	Heating	kPa	37.3	48.6	56.3	63.4
Piping Connections	Liquid Pipe (IN)		Type	PF MALE	PF MALE	PF MALE	PF MALE
			ø, mm (inch)	20A (3/4")	20A (3/4")	20A (3/4")	20A (3/4")
	Liquid Pipe (OUT)		Type	PF MALE	PF MALE	PF MALE	PF MALE
			ø, mm (inch)	20A (3/4")	20A (3/4")	20A (3/4")	20A (3/4")
	Heat insulation		-	Both inlet/outlet pipes	Both inlet/outlet pipes	Both inlet/outlet pipes	Both inlet/outlet pipes
Drain Pipe		Φ,mm	VP25 (OD 32, ID 25)	VP25 (OD 32, ID 25)	VP25 (OD 32, ID 25)	VP25 (OD 32, ID 25)	
Wiring connections	Communication	Min.	mm ²	0.75	0.75	0.75	0.75
		Remark	-	F1, F2	F1, F2	F1, F2	F1, F2
Sound	Sound Pressure	High / Mid / Low	dB(A)	37/33/30	41/35/30	42/38/35	45/40/35
	Sound Power	Cooling		56	60	58	60
Dimensions	Net Weight		kg	15.5	15.5	18.0	18.0
	Shipping Weight		kg	19.0	19.0	21.5	21.5
	Net Dimensions (W×H×D)		mm	840 × 204 × 840	840 × 204 × 840	840 × 246 × 840	840 × 246 × 840
	Shipping Dimensions (W×H×D)		mm	895 × 275 × 895	895 × 275 × 895	895 × 316 × 895	895 × 316 × 895
Casing	Material		-	Plastic	Plastic	Plastic	Plastic
Panel	Panel model		-	PC4NUSKAN PC4NUSKEN PC4NBSKAN	PC4NUSKAN PC4NUSKEN PC4NBSKAN	PC4NUSKAN PC4NUSKEN PC4NBSKAN	PC4NUSKAN PC4NUSKEN PC4NBSKAN
	Panel Net Weight		kg	5.9	5.9	5.9	5.9
	Shipping Weight		kg	8.5	8.5	8.5	8.5
	Net Dimensions (W×H×D)		mm	950 × 45 × 950	950 × 45 × 950	950 × 45 × 950	950 × 45 × 950
	Shipping Dimensions (W×H×D)		mm	1,005 × 100 × 1,005	1,005 × 100 × 1,005	1,005 × 100 × 1,005	1,005 × 100 × 1,005
Additional Accessories	Drain pump	Type	-	Built In	Built In	Built In	Built In
		Max. lifting Height / Displacement	mm / (cc/min)	750 / 400	750 / 400	750 / 400	750 / 400
	Filter		-	Microfibrous filter	Microfibrous filter	Microfibrous filter	Microfibrous filter

2. Specification

4Way Cassette

 NOTE

- Cooling : Indoor temperature 27°C DB, 19°C WB / Water In/Out temperature 7°C, 12°C
Heating : Indoor temperature 20°C DB, 15°C WB / Water In/Out temperature 45°C, 40°C
- Sound level was acquired in an anechoic room. Thus actual noise level may be different depending on the installation conditions.
- Specifications may be subject to change without prior notice.
- Select wire size based on the value of MCA

2. Specification

360 Cassette

Type				360 Cassette	360 Cassette	360 Cassette	360 Cassette
Model				AG060MN4PKH/EU	AG072MN4PKH/EU	AG090MN4PKH/EU	AG105MN4PKH/EU
Power Supply			Φ, V, Hz	1, 220~240, 50/60	1, 220~240, 50/60	1, 220~240, 50/60	1, 220~240, 50/60
Mode			-	HP	HP	HP	HP
Performance	Capacity (Nominal)	Cooling	kW	6.00	7.20	9.00	10.00
		Heating		7.30	8.50	10.00	10.70
Power	Power Input (Nominal)	Cooling	W	58.0	58.0	77.0	100.0
		Heating		58.0	58.0	77.0	100.0
	Current Input (Nominal)	Cooling	A	0.50	0.50	0.62	0.79
		Heating		0.50	0.50	0.62	0.79
Heat exchanger	Type		-	Fin & Tube	Fin & Tube	Fin & Tube	Fin & Tube
	Material	Fin	-	Al	Al	Al	Al
		Tube	-	Cu	Cu	Cu	Cu
	Fin Treatment		-	Green Hydrophile	Green Hydrophile	Green Hydrophile	Green Hydrophile
Fan	Type		-	Turbo Fan	Turbo Fan	Turbo Fan	Turbo Fan
	Quantity		EA	1	1	1	1
	Air Flow Rate	H/M/L	CMM	21.0/17.5/15.0	25.5/22.0/19.8	29.5/24.0/19.8	31.5/22.5/19.8
			l/s	-	-	-	-
Fan Motor	Type		-	BLDC	BLDC	BLDC	BLDC
	Output x n		W	65 x 1	97 x 1	97 x 1	97 x 1
Water	Water Flow Rate	Cooling	LPM	17.5	20.8	26.0	28.9
	Water Flow Rate	Heating	LPM	21.1	24.5	28.9	30.9
	Loss of Head	Cooling	kPa	27	26	38.5	47.4
	Loss of Head	Heating	kPa	37.6	35.6	47.4	53.2
Piping Connections	Liquid Pipe (IN)		Type	PF MALE	PF MALE	PF MALE	PF MALE
			ø, mm (inch)	20A (3/4")	20A (3/4")	20A (3/4")	20A (3/4")
	Liquid Pipe (OUT)		Type	PF MALE	PF MALE	PF MALE	PF MALE
			ø, mm (inch)	20A (3/4")	20A (3/4")	20A (3/4")	20A (3/4")
	Heat insulation		-	Both inlet/outlet pipes	Both inlet/outlet pipes	Both inlet/outlet pipes	Both inlet/outlet pipes
Drain Pipe		Φ,mm	VP25 (OD 32, ID 25)	VP25 (OD 32, ID 25)	VP25 (OD 32, ID 25)	VP25 (OD 32, ID 25)	
Wiring connections	Communication	Min.	mm ²	0.75	0.75	0.75	0.75
		Remark	-	F1, F2	F1, F2	F1, F2	F1, F2
Sound	Sound Pressure	High / Mid / Low	dB(A)	40/37/32	39/35/33	43/38/33	45/39/33
	Sound Power	Cooling		57	58	60	62
Dimensions	Net Weight		kg	21.0	25.0	25.0	25.0
	Shipping Weight		kg	25.9	30.4	30.4	30.4
	Net Dimensions (W×H×D)		mm	947 × 281 × 947	947 × 365 × 947	947 × 365 × 947	947 × 365 × 947
	Shipping Dimensions (W×H×D)		mm	990 × 330 × 990	990 × 414 × 990	990 × 414 × 990	990 × 414 × 990
Casing	Material		-				
Panel	Panel model		-	PC4NUDMAN PC4NUNMAN	PC4NUDMAN PC4NUNMAN	PC4NUDMAN PC4NUNMAN	PC4NUDMAN PC4NUNMAN
	Panel Net Weight		kg	3.6/2.7	3.6/2.7	3.6/2.7	3.6/2.7
	Shipping Weight		kg	6.3/5.3	6.3/5.3	6.3/5.3	6.3/5.3
	Net Dimensions (W×H×D)		mm	1,050 × 66 × 1,050	1,050 × 66 × 1,050	1,050 × 66 × 1,050	1,050 × 66 × 1,050
	Shipping Dimensions (W×H×D)		mm	1,093 × 85 × 1,083	1,093 × 85 × 1,083	1,093 × 85 × 1,083	1,093 × 85 × 1,083
Additional Accessories	Drain pump	Type	-	Built In	Built In	Built In	Built In
		Max. lifting Height / Displacement	mm / (cc/min)	750 / 400	750 / 400	750 / 400	750 / 400
	Filter		-	Microfibrinous filter	Microfibrinous filter	Microfibrinous filter	Microfibrinous filter

2. Specification

360 Cassette

 NOTE

- Cooling : Indoor temperature 27°C DB, 19°C WB / Water In/Out temperature 7°C, 12°C
Heating : Indoor temperature 20°C DB, 15°C WB / Water In/Out temperature 45°C, 40°C
- Sound level was acquired in an anechoic room. Thus actual noise level may be different depending on the installation conditions.
- Specifications may be subject to change without prior notice.
- Select wire size based on the value of MCA

3. Summary Table

Fan Coil Unit

Model		Fan Speed	Capacity (kW)			Airflow (CMM)	Sound Pressure (dBA)	Sound Power (dBA)
			Cooling	Sensible	Heating			
1Way Cassette	AG026MN1DEH/EU	High	2.6	1.88	2.9	6.8	32	49
		Mid	2.3	1.7	2.7	5.8	30	-
		Low	1.9	1.4	2.5	4.9	28	-
	AG032MN1DEH/EU	High	3	2.2	3.35	7.8	37	52
		Mid	2.7	2	3.1	6.8	33	-
		Low	1.9	1.4	2.7	4.9	28	-
	AG042MN1DEH/EU	High	4.15	3.07	5	14.6	40	58
		Mid	3.6	2.7	4.6	12.6	37	-
		Low	3.1	2.3	4.3	10.7	33	-
4Way Cassette	AG060MN4DKH/EU	High	6	4.45	7.3	18.9	37	56
		Mid	5.3	3.9	6.8	16.5	33	-
		Low	4.5	3.3	6.2	13.6	30	-
	AG072MN4DKH/EU	High	7.2	5.41	8.5	21.3	41	60
		Mid	6.3	4.7	7.9	18.2	35	-
		Low	4.7	3.5	6.8	13.6	30	-
	AG090MN4DKH/EU	High	9	6.71	10	23.3	42	58
		Mid	8.3	6.2	9.6	21.3	38	-
		Low	7.7	5.7	9.1	19.4	35	-
	AG105MN4DKH/EU	High	10	7.56	10.7	30.1	45	60
		Mid	8.9	6.7	10	26.2	40	-
		Low	6.6	5	8.6	19.4	35	-
360 Cassette	AG060MN4PKH/EU	High	6	4.45	7.3	21	40	57
		Mid	5.1	3.8	6.7	17.5	37	-
		Low	4.4	3.3	6.2	15	32	-
	AG072MN4PKH/EU	High	7.2	5.41	8.5	25.5	39	58
		Mid	6.3	4.7	7.9	22	35	-
		Low	5.7	4.3	7.5	19.8	33	-
	AG090MN4PKH/EU	High	9	6.71	10	29.5	43	60
		Mid	7.5	5.6	9	24	38	-
		Low	6.2	4.6	8.2	19.8	33	-
	AG105MN4PKH/EU	High	10	7.56	10.7	31.5	45	62
		Mid	7.4	5.6	9	22.5	39	-
		Low	6.5	4.9	8.5	19.8	33	-

 **NOTE**

- Sound data is based on cooling operation.

3. Summary Table

Fan Coil Unit

Electrical Characteristics

Model		Power Supply (Φ, #, V, Hz)	Power Input (W)	Current Input (A)	MCA (A)	MFA (A)	FLA (A)	
1Way	AG026MN1DEH	1, 2, 220~240, 50	47	0.24	0.3	15	0.22	
	AG032MN1DEH		50	0.26	0.3	15	0.23	
	AG042MN1DEH		55	0.29	0.4	15	0.38	
4Way	AG060MN4DKH	1,2,220~240, 50/60	50	0.37	0.5	15	0.46	
	AG072MN4DKH		73	0.5	0.8	15	0.66	
	AG090MN4DKH		82	0.58	0.8	15	0.60	
	AG105MN4DKH		99	0.79	1.0	15	0.75	
360	AG060MN4PKH		1,2,220~240, 50/60	58	0.50	0.6	15	0.49
	AG072MN4PKH			58	0.50	0.6	15	0.46
	AG090MN4PKH			77	0.62	0.8	15	0.6
	AG105MN4PKH			100	0.79	1.0	15	0.75



NOTE

- MCA : Minimum circuit amperes
- MFA : Maximum fuse amperes
- FLA : Full load amperes
- Select wire size based on the value of MCA

4. Dimensional Drawing

1Way Cassette

AG026/032MN1DEH/EU

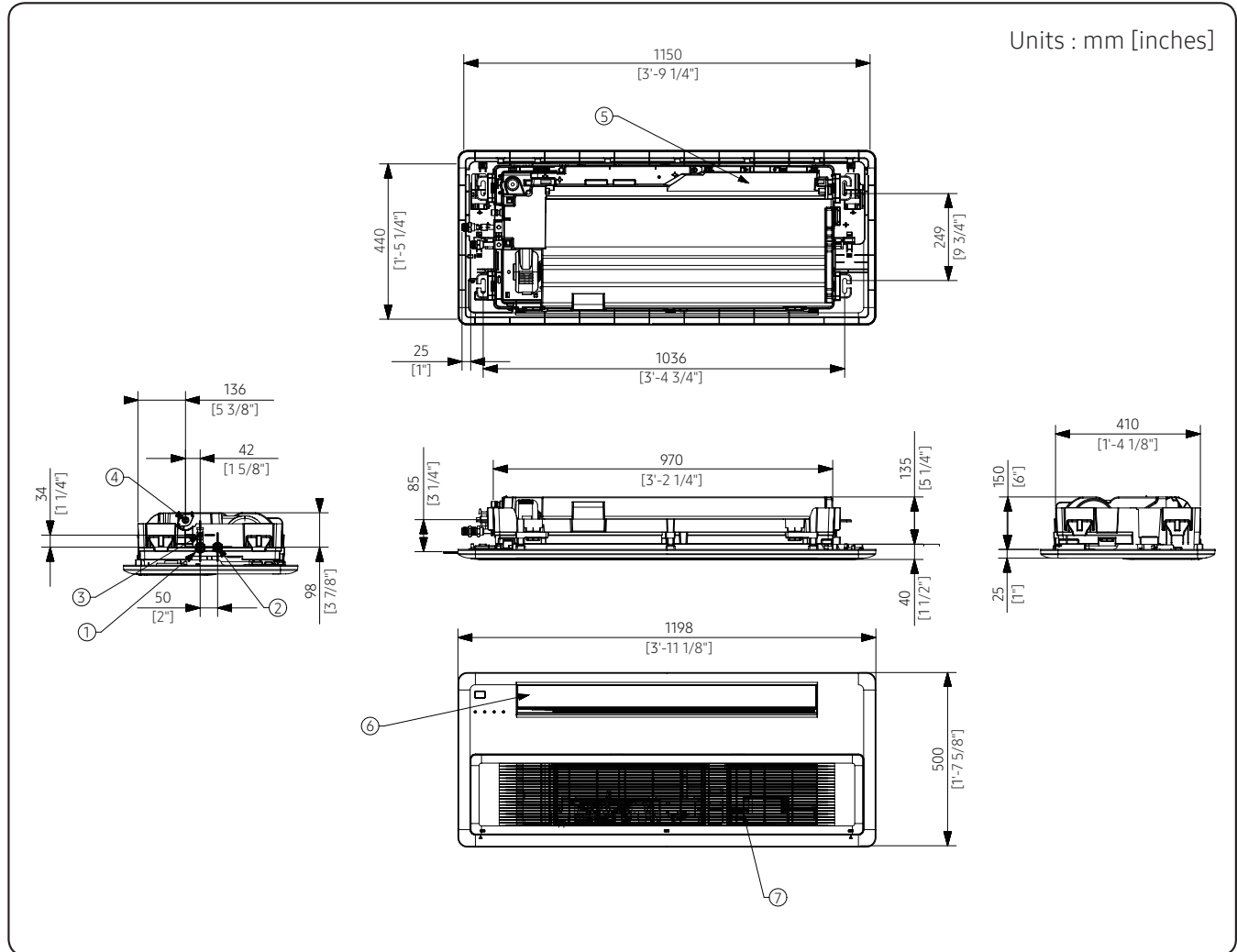

No	Name	Description
1	Water pipe connection out	PF Male 3/4" (20A)
2	Water pipe connection in	PF Male 3/4" (20A)
3	Air vent valve	-
4	Drain hose	VP20 (OD26, ID20)
5	Power supply & Communication wiring conduit	-
6	Air discharge part	-
7	Air suction part	-

4. Dimensional Drawing

1Way Cassette

AG042MN1DEH/EU

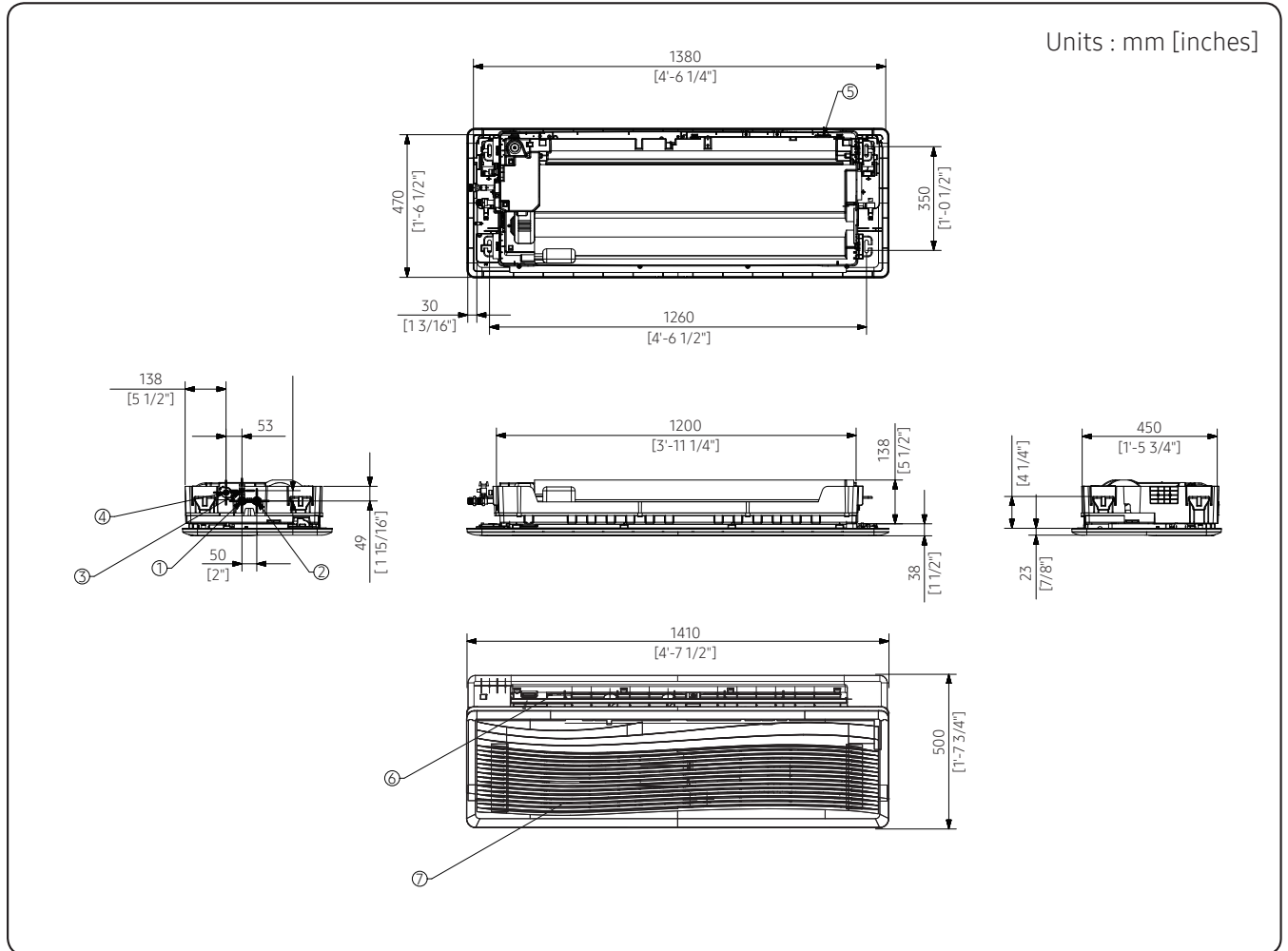

No	Name	Description
1	Water pipe connection out	PF Male 3/4" (20A)
2	Water pipe connection in	PF Male 3/4" (20A)
3	Air vent valve	-
4	Drain hose	VP25 (OD32, ID25)
5	Power supply & Communication wiring conduit	-
6	Air discharge part	-
7	Air suction part	-

4. Dimensional Drawing

4Way Cassette

AG060/072/090/105MN4DKH/EU

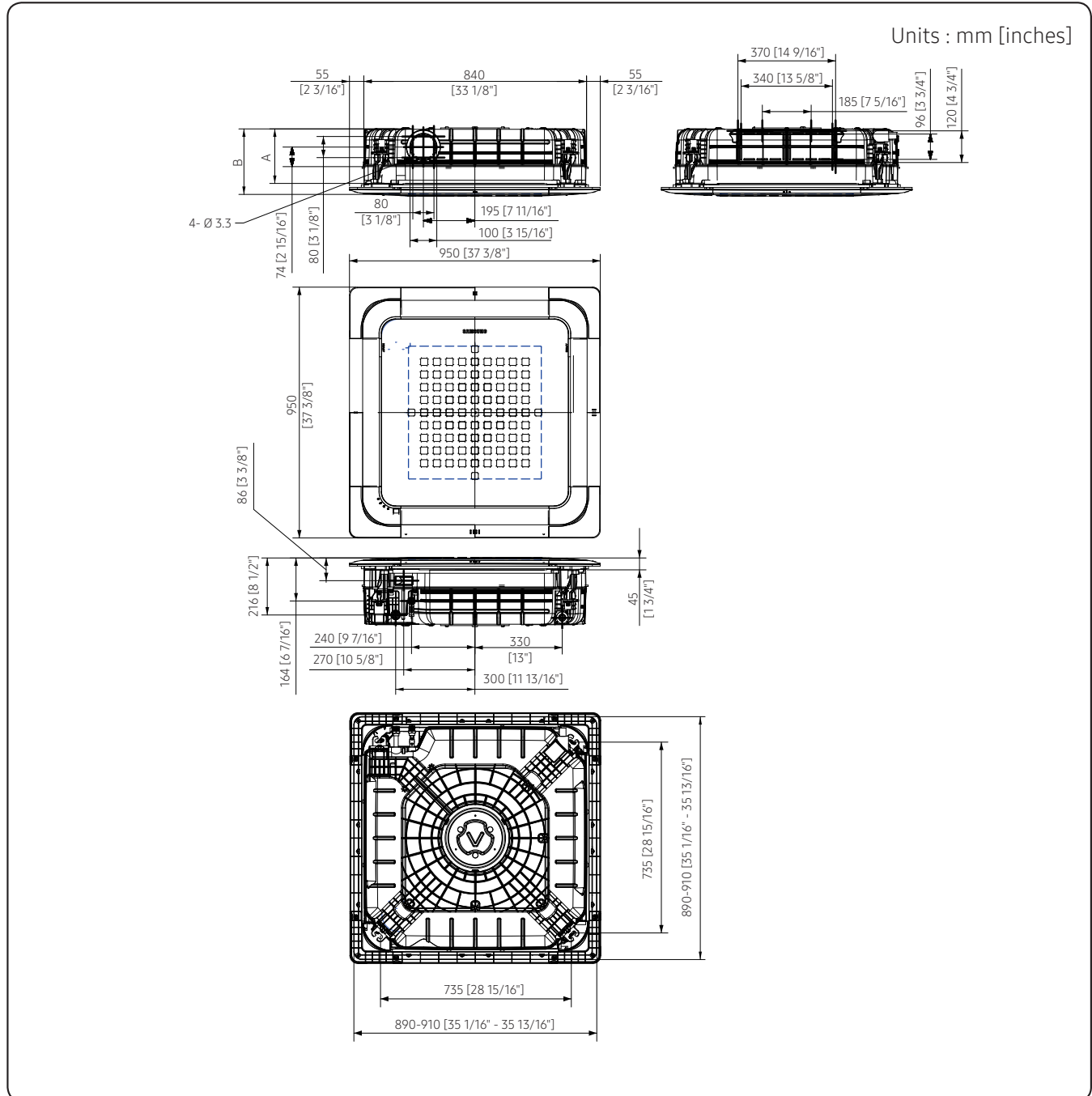

Type	A Type	B Type
Model	AG060MN4DKH/EU	AG090MN4DKH/EU
	AG072MN4DKH/EU	AG105MN4DKH/EU
A	204 [8 1/16"]	246 [9 11/16"]
B	253 [9 15/16"]	295 [11 5/8"]
Pipe connection	PF 3/4" Male	
Drain pipe connection	VP25 (OD32, ID25)	

4. Dimensional Drawing

360 Cassette (Square Type)

AG060/072/090/105MN4PKH/EU

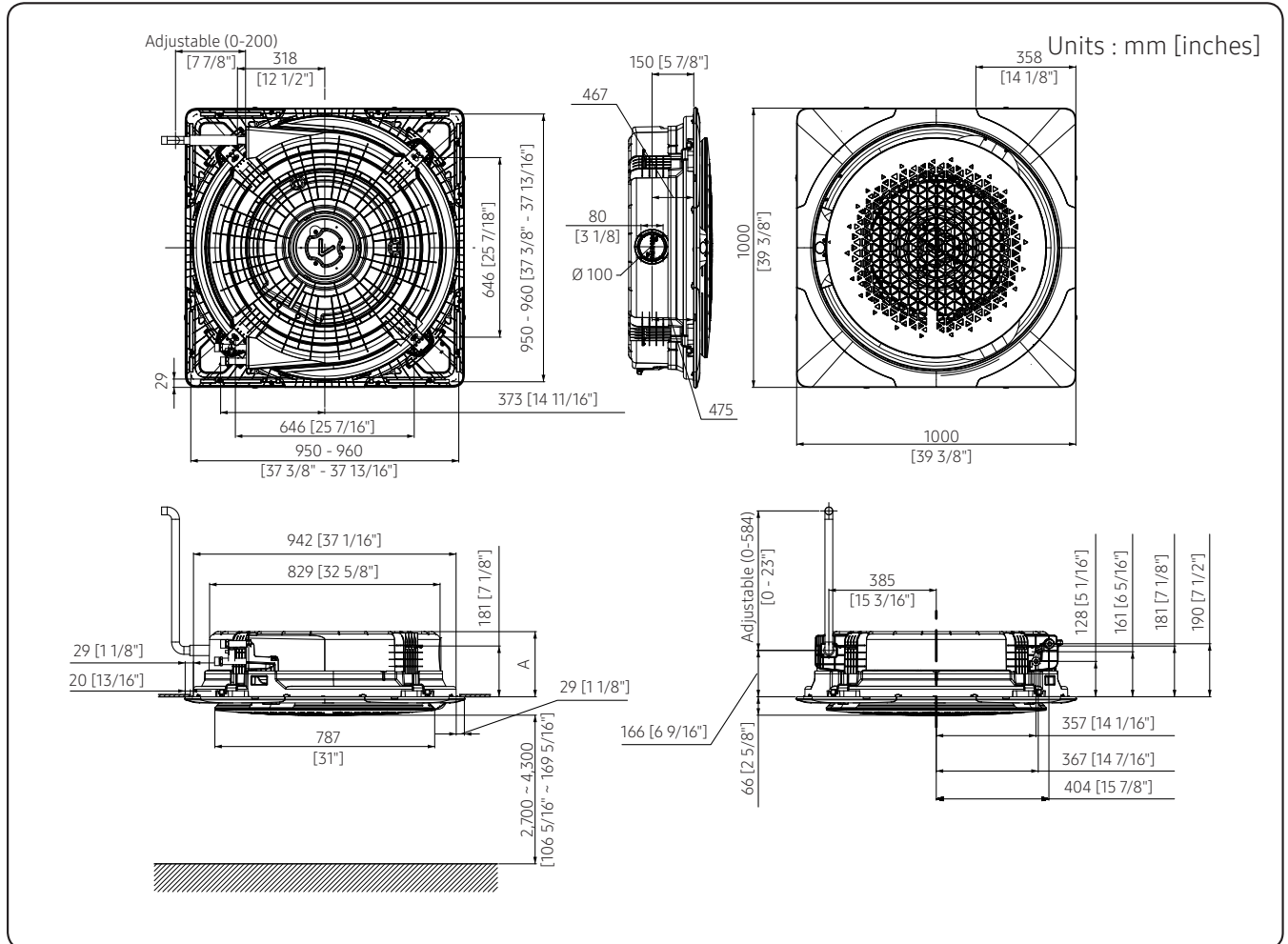

Type	A Type	B Type
Model	AG060MN4PKH/EU	AG072MN4PKH/EU AG090MN4PKH/EU AG105MN4PKH/EU
A	233 [9 3/16"]	317 [12 1/2"]
Pipe connection	PF 3/4" Male	
Drain pipe connection	VP25 (OD32, ID25)	

4. Dimensional Drawing

360 Cassette (Circular Type)

AG060/072/090/105MN4PKH/EU

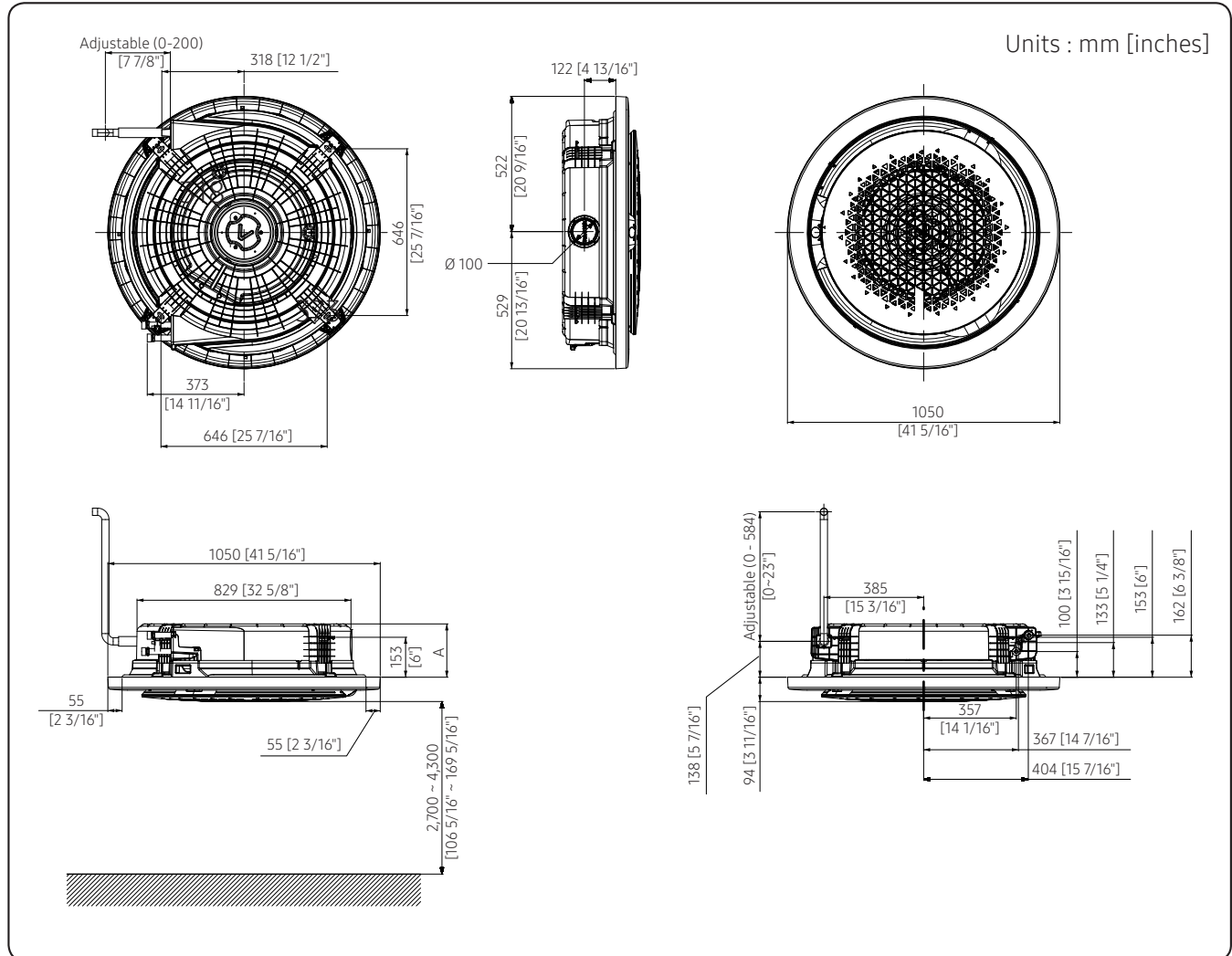

Type	A Type	B Type
Model	AG060MN4PKH/EU	AG072MN4PKH/EU AG090MN4PKH/EU AG105MN4PKH/EU
A	205	289
Pipe connection	PF 3/4" Male	
Drain pipe connection	VP25 (OD32, ID25)	

5. Center of Gravity

1Way Cassette

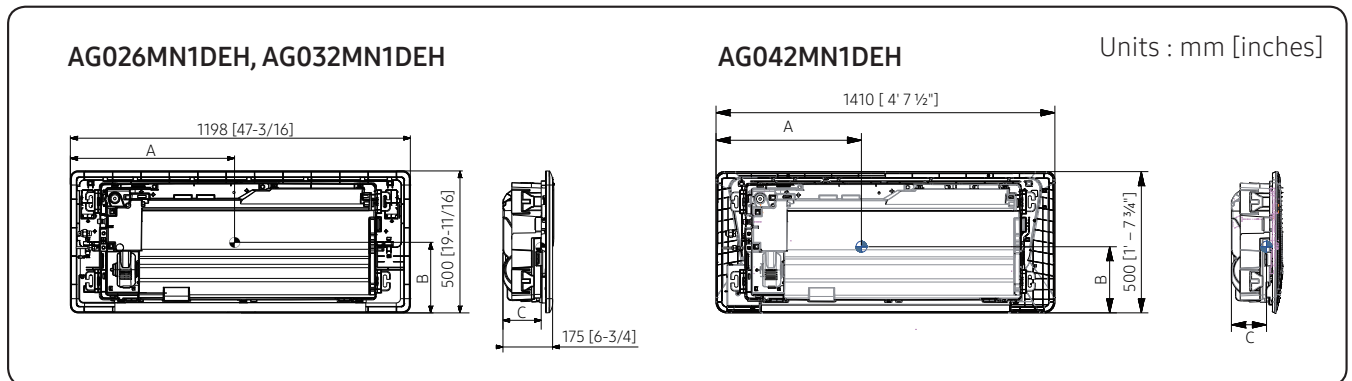

Model	A	B	C
AG026MN1DEH	555 [21-7/8]	220 [8-5/8]	108 [4-1/4]
AG032MN1DEH	555 [21-7/8]	220 [8-5/8]	108 [4-1/4]
AG042MN1DEH	755 [29-5/8]	200 [7-7/8]	108 [4-1/4]

4Way Cassette

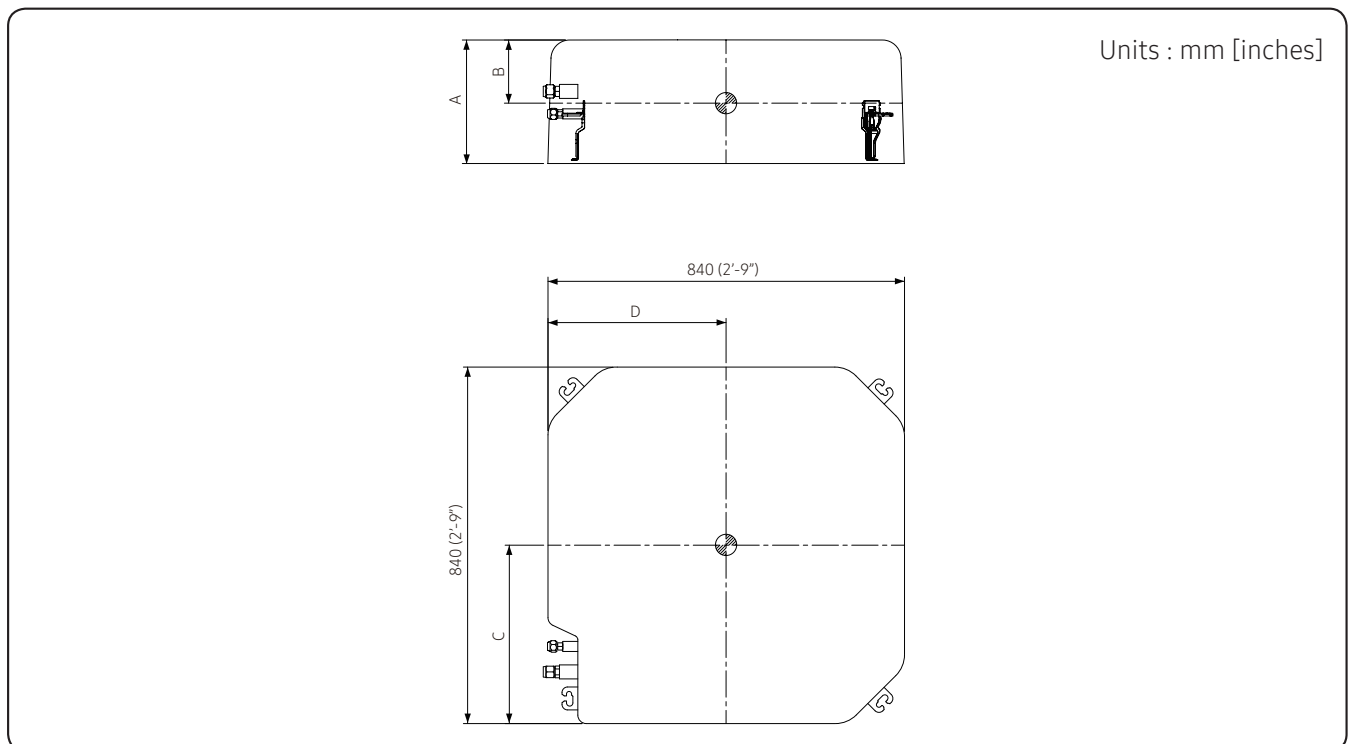

Model	A	B	C	D
AG060MN4DKH	204 [8]	70 [2-3/4]	410 [16-1/8]	360 [14-3/16]
AG072MN4DKH				
AG090MN4DKH	246 [9-5/8]	91 [3-1/2]	410 [16-1/8]	360 [14-3/16]
AG105MN4DKH				

5. Center of Gravity

360 Cassette

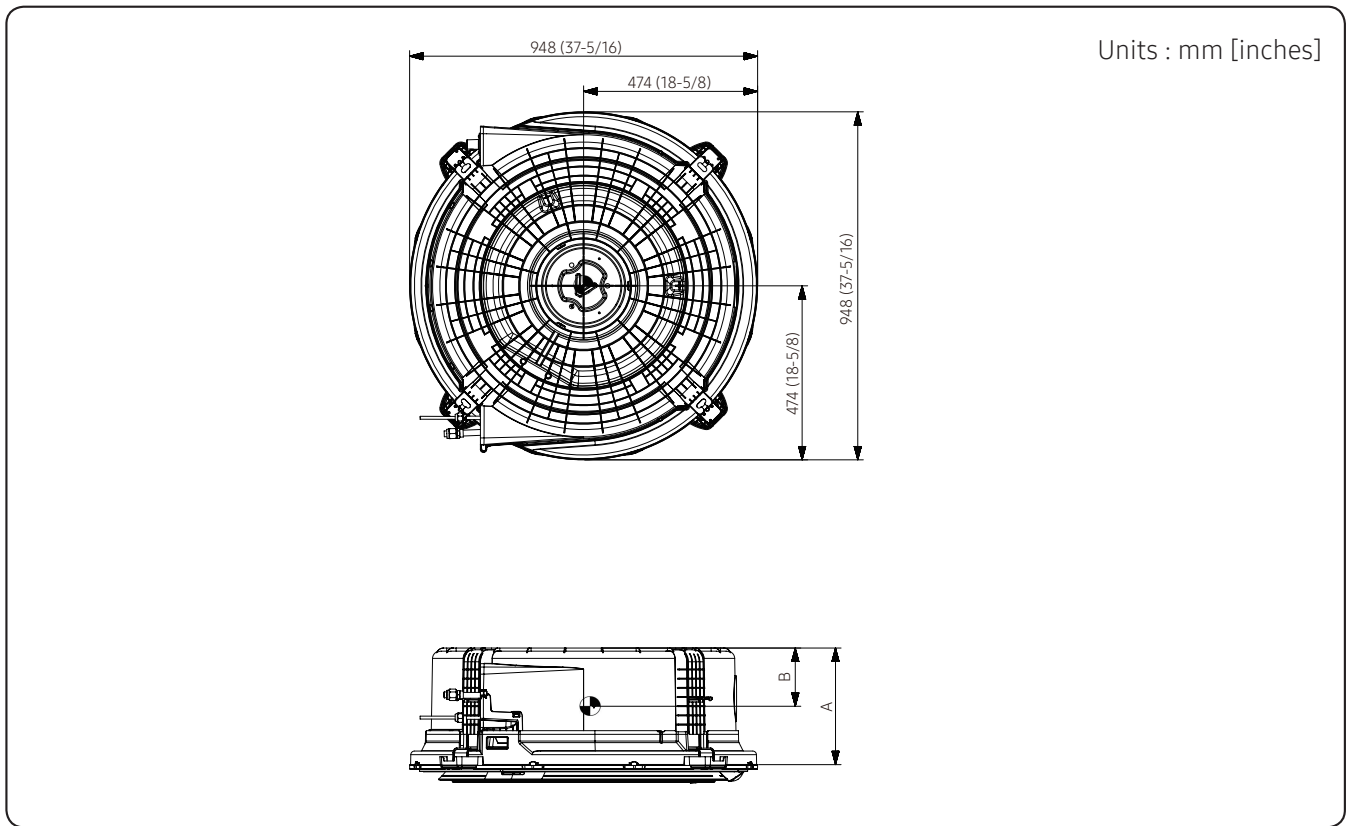

Model	A	B
AG060MN4PKH	233 [9-3/16]	165 [6-1/2]
AG072MN4PKH AG090MN4PKH AG105MN4PKH	317 [12-1/2]	220 [8-5/8]

6. Electrical Wiring Diagram

1Way Cassette

- AG026MN1DEH/EU, AG032MN1DEH/EU

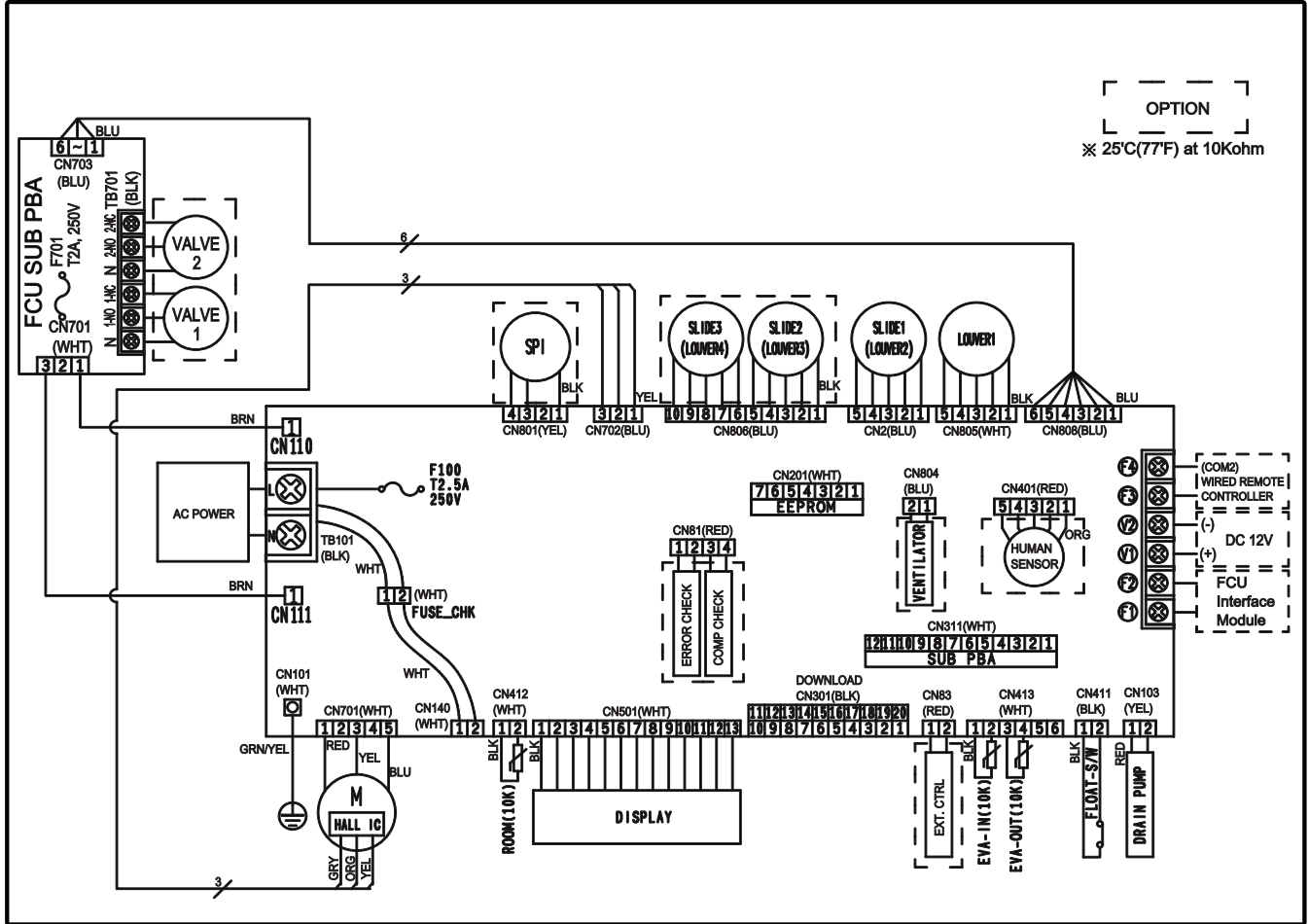

MAIN PCB	Printed circuit board (Main)	FLOATS/W	Float Switch	EXT.CTRL	External Control
SUB PCB	Printed circuit board (Sub)	DRAIN PUMP	Drain Pump	EVA-IN	Thermistor (Eva-In) 25°C at 10Kohm
EEPROM	EEPROM Sub PBA	LOUVER	Up/Down, Left/Right Blade	EVA-OUT	Thermistor (Eva-Out) 25°C at 10Kohm
M (HALL IC)	AC Motor (Indoor Fan)	SPI	Samsung Plasma Ion	ROOM	Thermistor (Air) 25°C at 10Kohm
DISPLAY	LED Lamp Display	T2.5A 250V	FUSE		

NOTE

- This wiring diagram applies only to the Fan Coil Unit.
- Colors blk: black, red: red, blu: blue, wht: white, yel: yellow, brn: brown, sky: skyblue
- For connection wiring indoor-outdoor transmission F1-F2, outdoor-outdoor transmission F3-F4, refer to the installation manual.
- ⊕ Protective earth(SCREW), □□□□ : connector, $\frac{N}{\text{---}}$: The wire quantity

6. Electrical Wiring Diagram

1Way / 4Way Cassette

- 1Way Cassette : AG042MN1DEH/EU
- 4Way Cassette : AG060MN4DKH/EU, AG072MN4DKH/EU, AG090MN4DKH/EU, AG105MN4DKH/EU

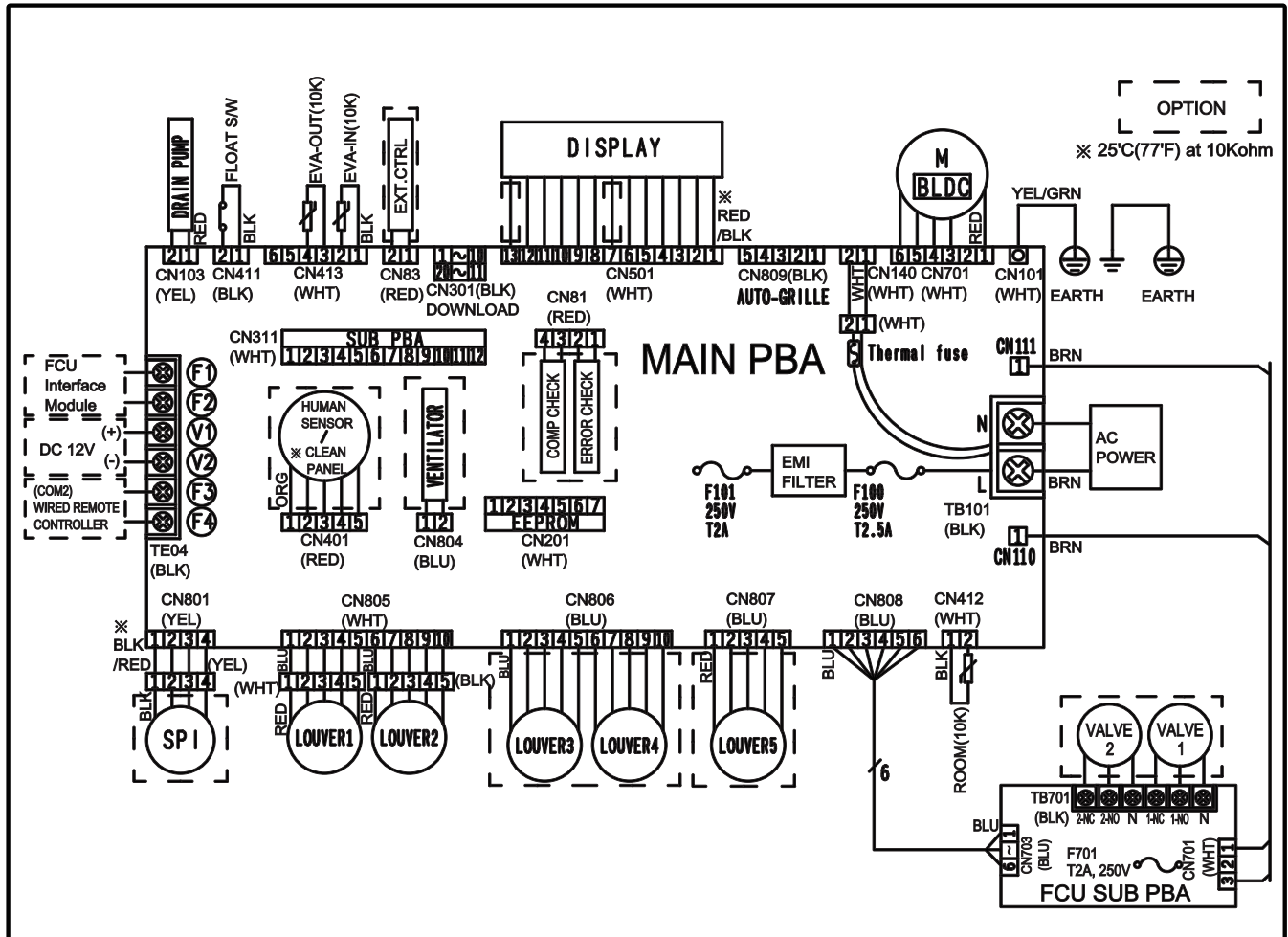

MAIN PCB	Printed circuit board (Main)	FLOAT S/W	Float Switch	EXT.CTRL	External Control
SUB PCB	Printed circuit board (Sub)	DRAIN PUMP	Drain Pump	EVA-IN	Thermistor (Eva-In) 25°C at 10Kohm
EEPROM	EEPROM Sub PBA	LOUVER	Up/Down, Left/Right Blade	EVA-OUT	Thermistor (Eva-Out) 25°C at 10Kohm
M (BLDC)	BLDC Motor (Indoor Fan)	SPI	Samsung Plasma Ion	ROOM	Thermistor (Air) 25°C at 10Kohm
DISPLAY	LED Lamp Display	250V T2.5A	FUSE		

NOTE

- This wiring diagram applies only to the Fan Coil Unit.
- Colors blk: black, red: red, blu: blue, wht: white, yel: yellow, brn: brown, sky: skyblue
- For connection wiring indoor-outdoor transmission F1-F2, outdoor-outdoor transmission F3-F4, refer to the installation manual.
- Protective earth(SCREW), : connector, : The wire quantity

6. Electrical Wiring Diagram

360 Cassette

- AG060MN4PKH/EU, AG072MN4PKH/EU, AG090MN4PKH/EU, AG105MN4PKH/EU

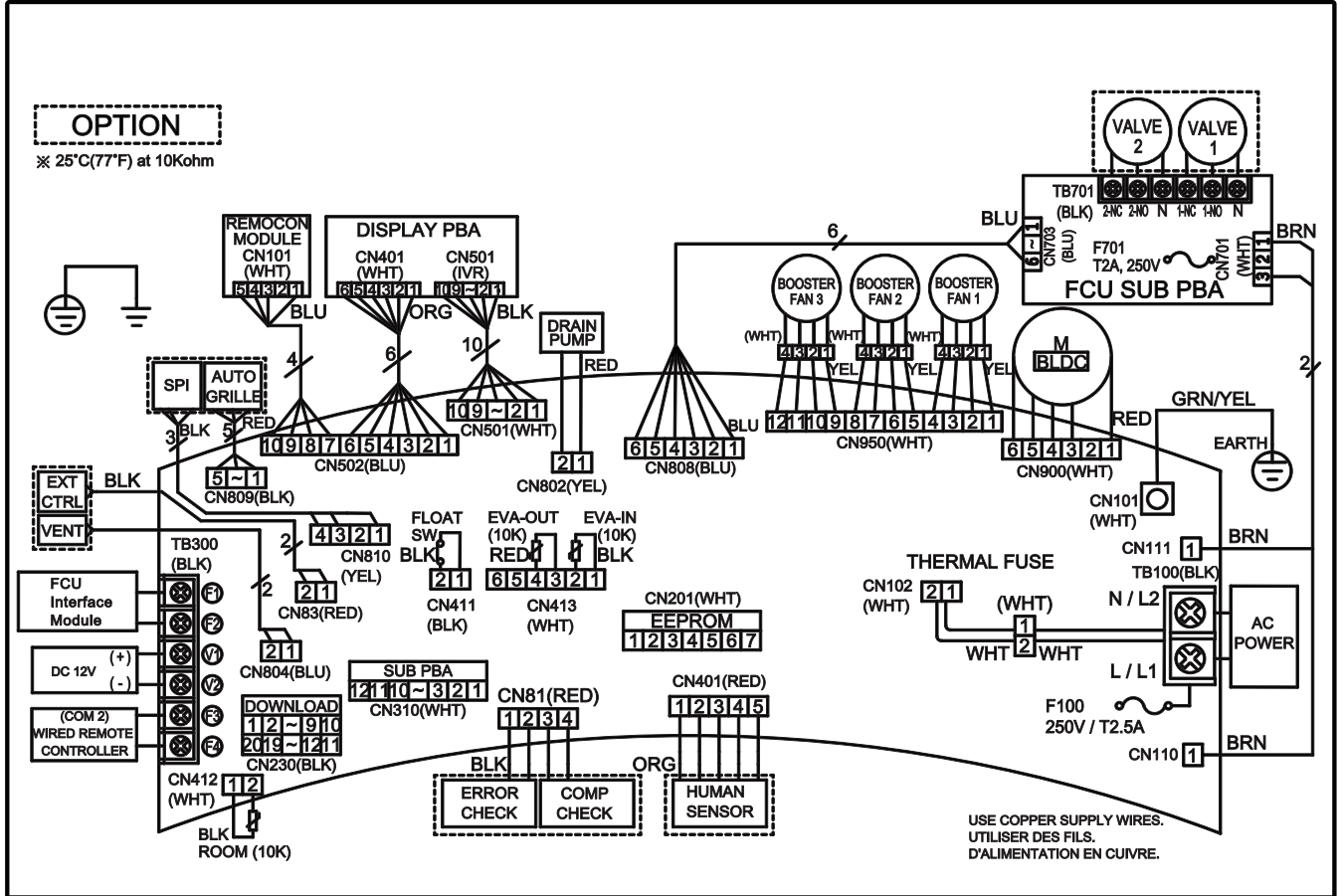

MAIN PCB	Printed circuit board (Main)	FLOATS/W	Float Switch	EXT.CTRL	External Control
SUB PCB	Printed circuit board (Sub)	DRAIN PUMP	Drain Pump	EVA-IN	Thermistor (Eva-In) 25°C at 10Kohm
EEPROM	EEPROM Sub PBA	BOOSTER FAN	Booster Fan (DC)	EVA-OUT	Thermistor (Eva-Out) 25°C at 10Kohm
M (BLDC)	BLDC Motor (Indoor Fan)	SPI	Samsung Plasma Ion	ROOM	Thermistor (Air) 25°C at 10Kohm
DISPLAY	LED Lamp Display	250V T2.5A	FUSE		

NOTE

- This wiring diagram applies only to the Fan Coil Unit.
- Colors blk: black, red: red, blu: blue, wht: white, yel: yellow, brn: brown, sky: skyblue
- For connection wiring indoor-outdoor transmission F1-F2, outdoor-outdoor transmission F3-F4, refer to the installation manual.
- ⊕ Protective earth(SCREW), □□□□ : connector, $\frac{N}{\text{---}}$: The wire quantity

7. Sound Data

1Way Cassette

Sound Pressure level

Unit: dB(A)

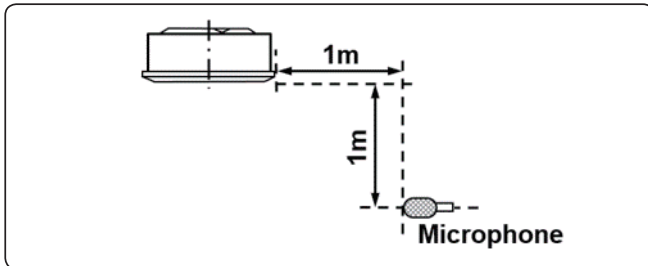

Model	HIGH	MID	LOW
AG026MN1DEH/EU	32	30	28
AG032MN1DEH/EU	37	33	29
AG042MN1DEH/EU	40	37	33

- NR Curve

1) AG026MN1DEH/EU

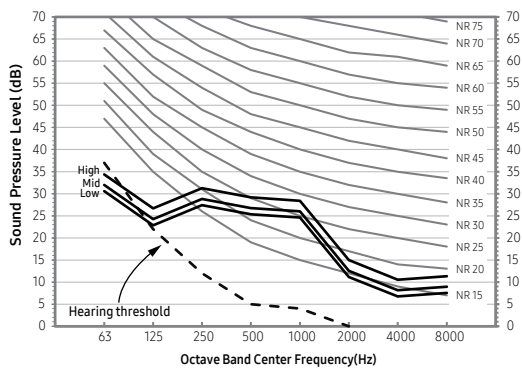

2) AG032MN1DEH/EU

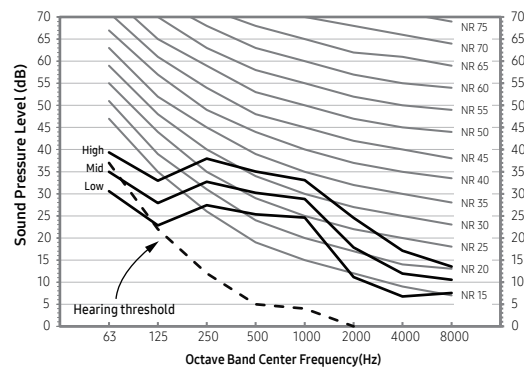

3) AG042MN1DEH/EU

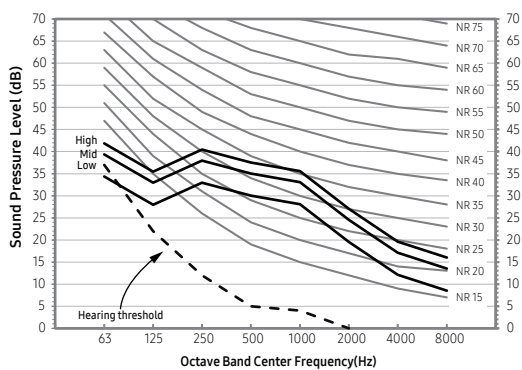

NOTE

- Specifications may be subject to change without prior notice.
- Sound Pressure Level
 - Sound pressure level is obtained in an anechoic room.
 - Sound pressure level is a relative value, depending on the distance and acoustic environment.
 - Sound pressure level may differ depending on operation condition.
 - dBA = A-weighted sound pressure level
 - Reference acoustic pressure 0dB = 20μPa

7. Sound Data

4Way Cassette

Sound Pressure level

Unit: dB(A)

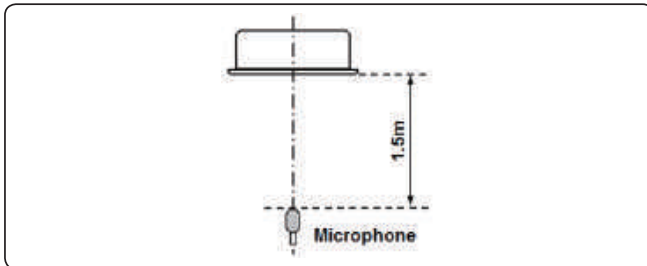

Model	HIGH	MID	LOW
AG060MN4DKH/EU	37	33	30
AG072MN4DKH/EU	41	35	30
AG090MN4DKH/EU	42	38	35
AG105MN4DKH/EU	45	40	35

- NR Curve

1) AG060MN4DKH/EU

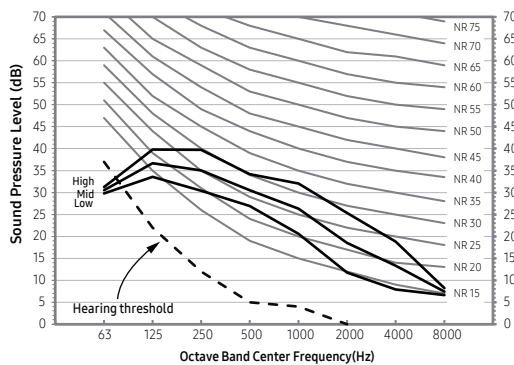

2) AG072MN4DKH/EU

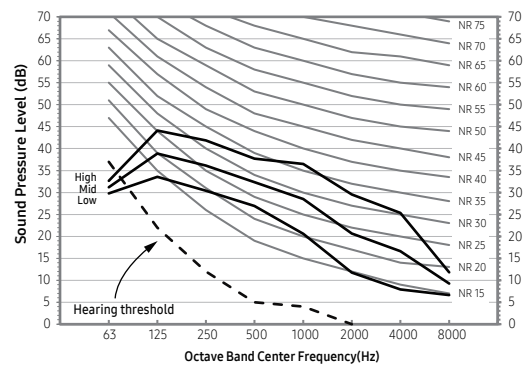

3) AG090MN4DKH/EU

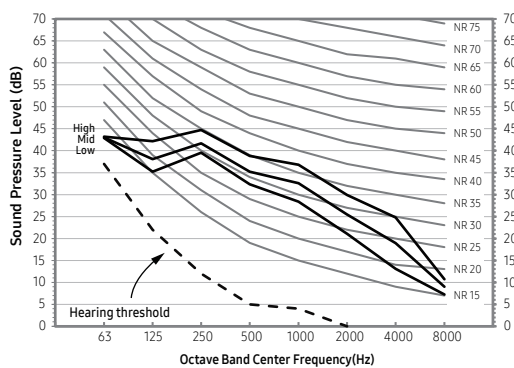

4) AG105MN4DKH/EU

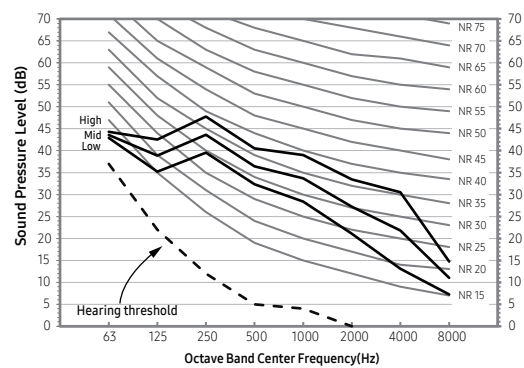

NOTE

- Specifications may be subject to change without prior notice.
- Sound Pressure Level
 - Sound pressure level is obtained in an anechoic room.
 - Sound pressure level is a relative value, depending on the distance and acoustic environment.
 - Sound pressure level may differ depending on operation condition.
 - dBA = A-weighted sound pressure level
 - Reference acoustic pressure 0dB = 20μPa

7. Sound Data

360 Cassette

Sound Pressure level

Unit: dB(A)

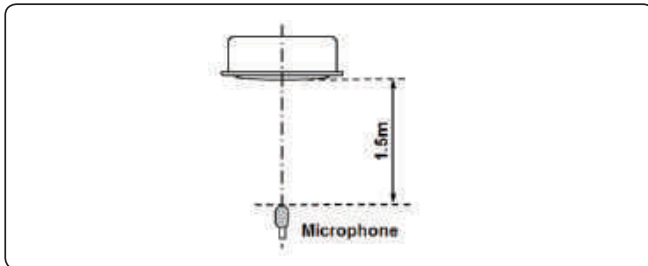

Model	HIGH	MID	LOW
AG060MN4PKH/EU	40	37	32
AG072MN4PKH/EU	39	35	33
AG090MN4PKH/EU	43	38	33
AG105MN4PKH/EU	45	39	33

- NR Curve

1) AG060MN4PKH/EU

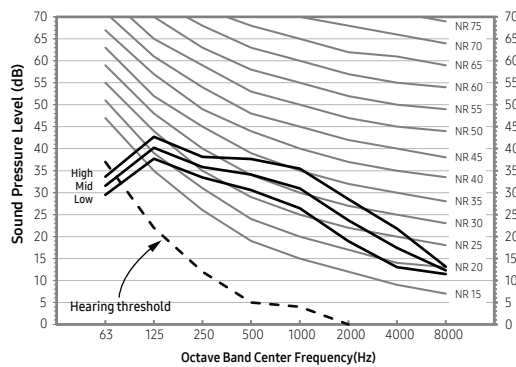

2) AG072MN4PKH/EU

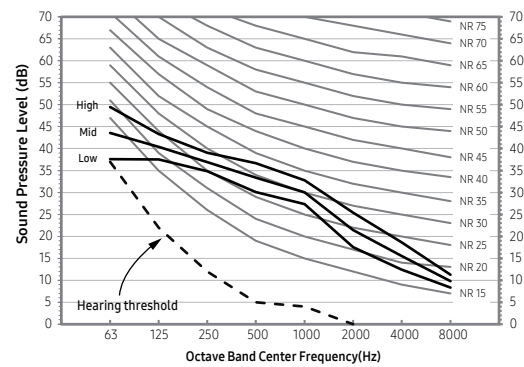

3) AG090MN4PKH/EU

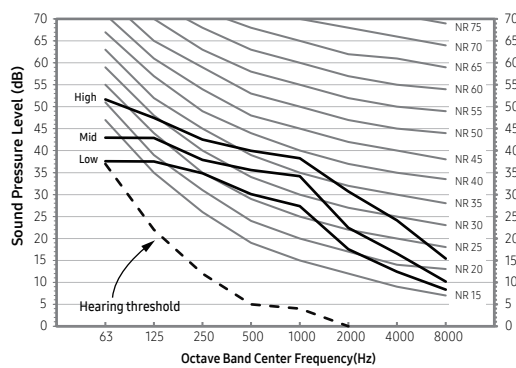

4) AG105MN4PKH/EU

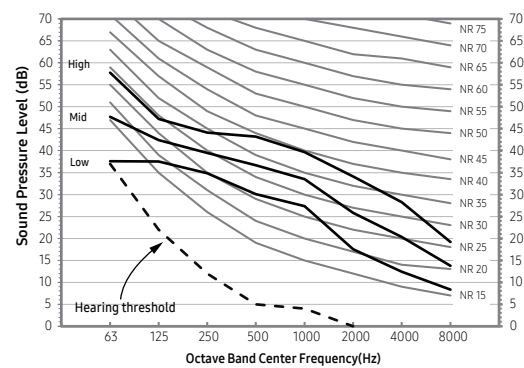

NOTE

- Specifications may be subject to change without prior notice.
- Sound Pressure Level
 - Sound pressure level is obtained in an anechoic room.
 - Sound pressure level is a relative value, depending on the distance and acoustic environment.
 - Sound pressure level may differ depending on operation condition.
 - dBA = A-weighted sound pressure level
 - Reference acoustic pressure 0dB = 20μPa

7. Sound Data

1Way Cassette

Sound Power level

NOTE

- Specifications may be subject to change without prior notice.
 - Sound power level is an absolute value that a sound source generates
 - dBA = A weighted sound power level
 - Reference power : 1pW
 - Measured according to ISO

Unit: dB(A)

Model	Cooling
AG026MN1DEH/EU	49
AG032MN1DEH/EU	52
AG042MN1DEH/EU	58

1) AG026MN1DEH/EU

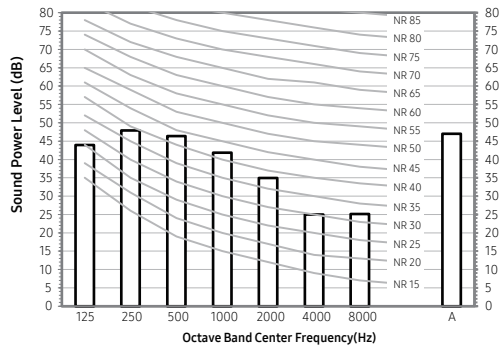

2) AG032MN1DEH/EU

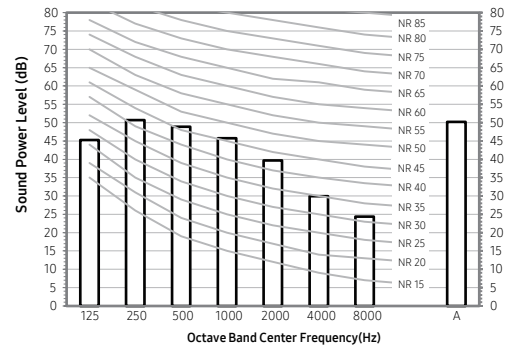

3) AG042MN1DEH/EU

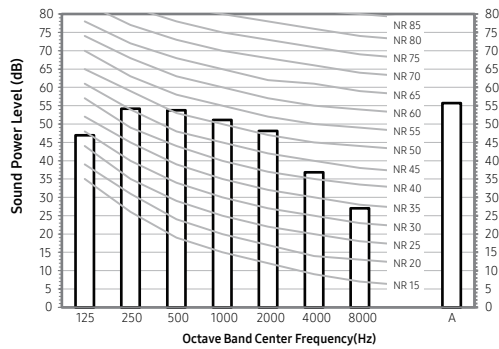

7. Sound Data

4Way Cassette

Sound Power level



NOTE

- Specifications may be subject to change without prior notice.
 - Sound power level is an absolute value that a sound source generates
 - dBA = A weighted sound power level
 - Reference power : 1pW
 - Measured according to ISO

Unit: dB(A)

Model	Cooling
AG060MN4DKH/EU	56
AG072MN4DKH/EU	60
AG090MN4DKH/EU	58
AG105MN4DKH/EU	60

1) AG060MN4DKH/EU

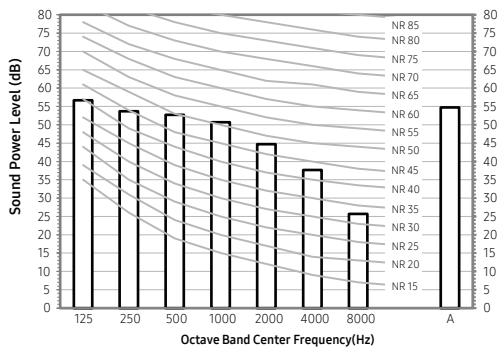

2) AG072MN4DKH/EU

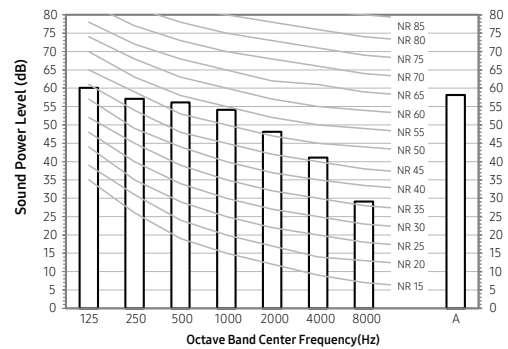

3) AG090MN4DKH/EU

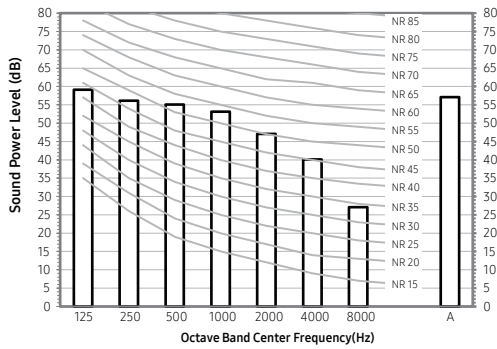

4) AG105MN4DKH/EU

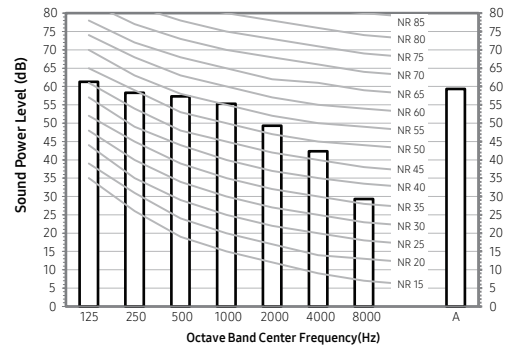

7. Sound Data

360 Cassette

Sound Power level

NOTE

- Specifications may be subject to change without prior notice.
 - Sound power level is an absolute value that a sound source generates
 - dBA = A weighted sound power level
 - Reference power : 1pW
 - Measured according to ISO

Unit: dB(A)

Model	Cooling
AG060MN4PKH/EU	57
AG072MN4PKH/EU	58
AG090MN4PKH/EU	60
AG105MN4PKH/EU	62

1) AG060MN4PKH/EU

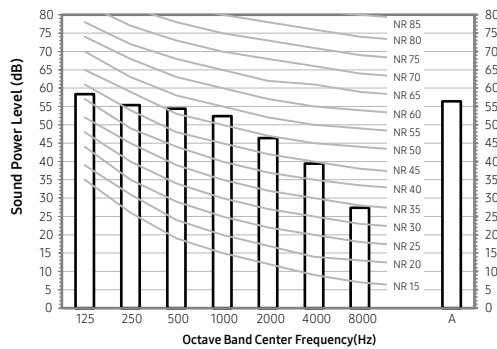

2) AG072MN4PKH/EU

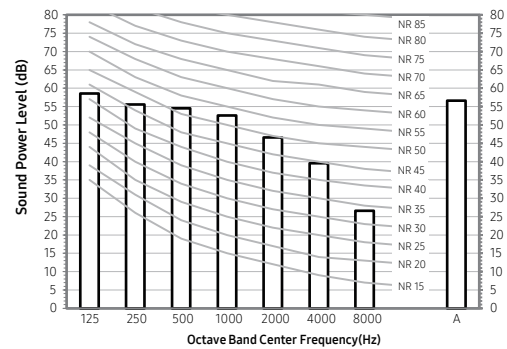

3) AG090MN4PKH/EU

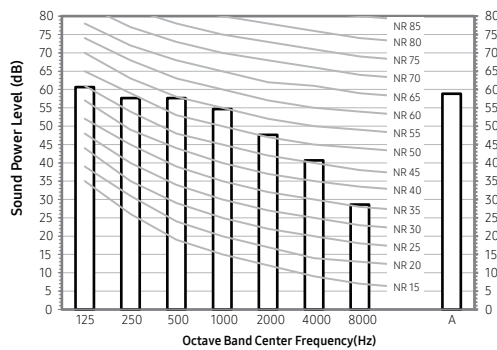

4) AG105MN4PKH/EU

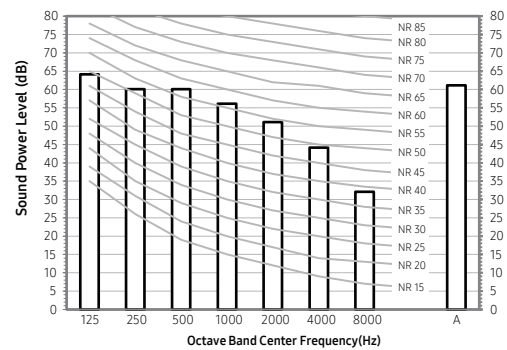

8. Temperature and Airflow Distribution

1Way Cassette

• AG026MN1DEH/EU

Discharge angle : 60

Cooling Air Velocity distribution

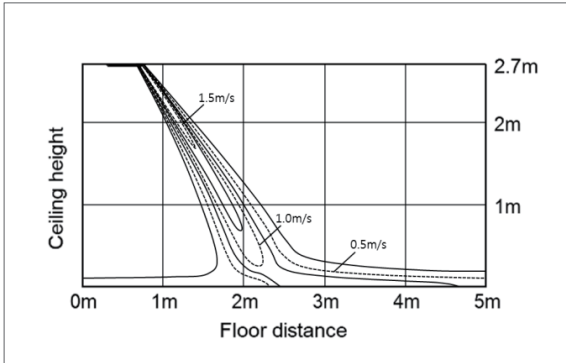

Cooling temperature distribution

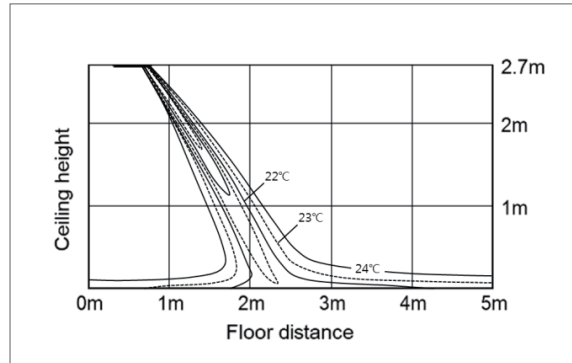

Heating Air Velocity distribution

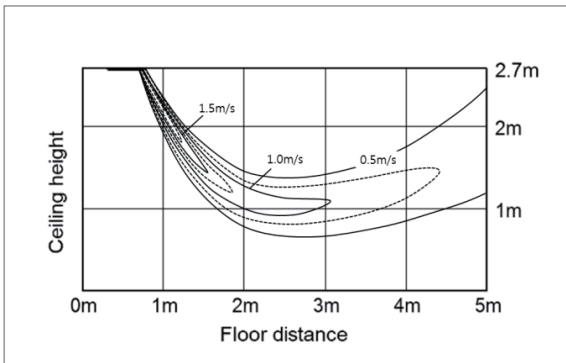

Heating temperature distribution

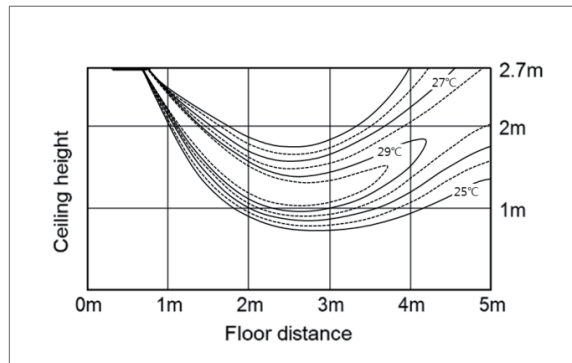

• AG032MN1DEH/EU

Discharge angle : 60

Cooling Air Velocity distribution

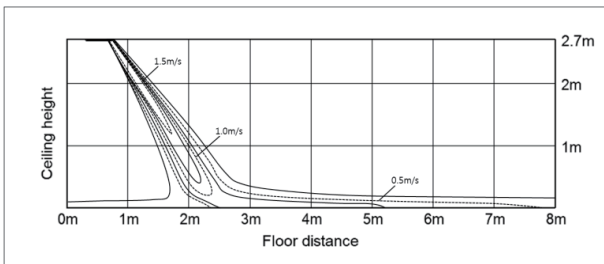

Cooling temperature distribution

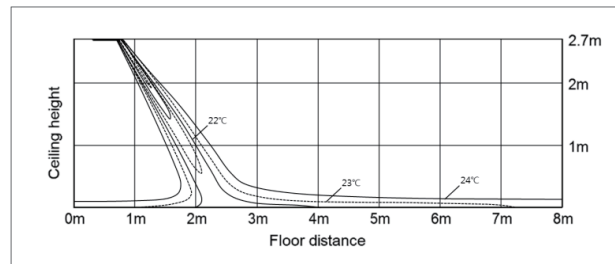

Heating Air Velocity distribution

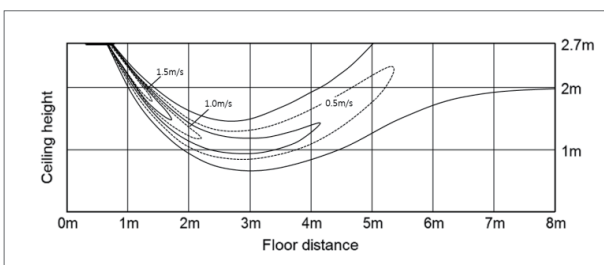

Heating temperature distribution

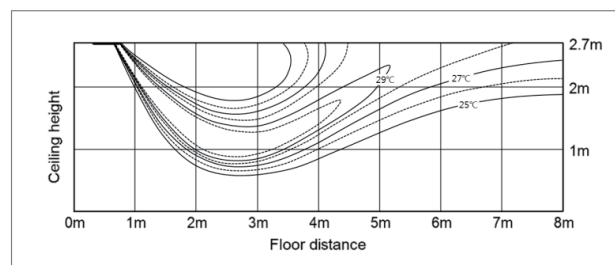

8. Temperature and Airflow Distribution

1Way Cassette

- AG042MN1DEH/EU

Discharge angle : 60

Cooling Air Velocity distribution

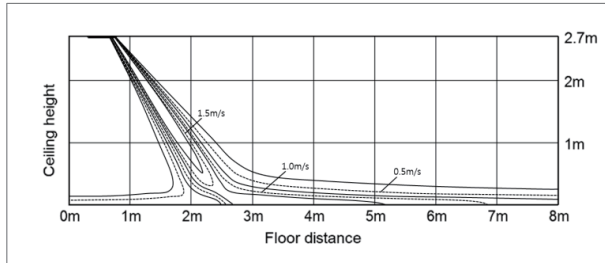

Cooling temperature distribution

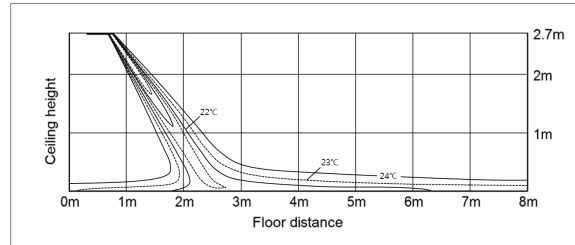

Heating Air Velocity distribution

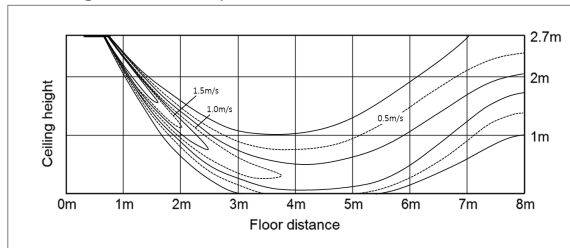

Heating temperature distribution

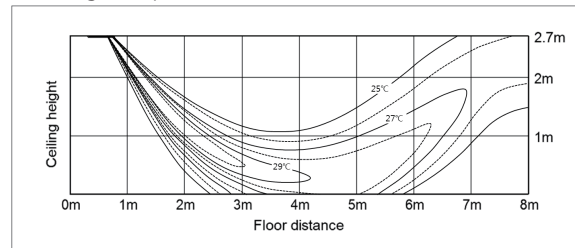

8. Temperature and Airflow Distribution

4Way Cassette

• AG060MN4DKH/EU

Discharge angle : 45

Cooling Air Velocity distribution

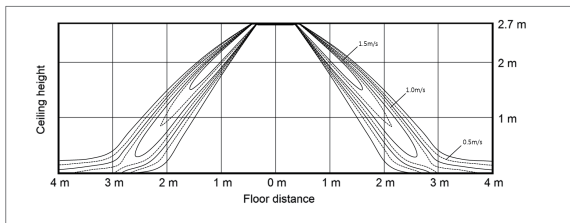

Cooling temperature distribution

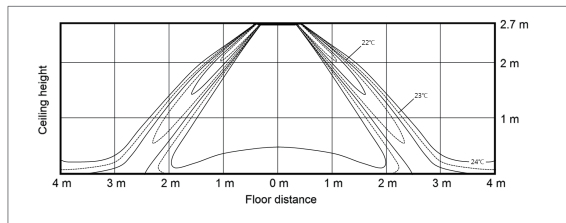

Heating Air Velocity distribution

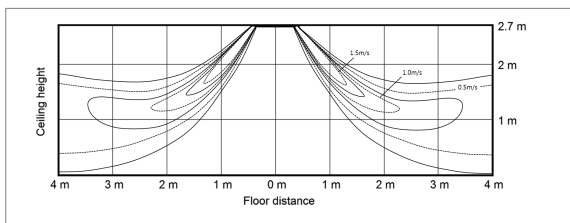

Heating temperature distribution

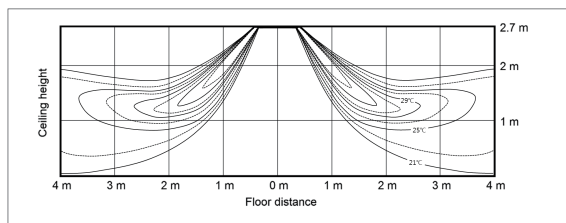

Discharge angle : 52

• AG072MN4DKH/EU

Discharge angle : 45

Cooling Air Velocity distribution

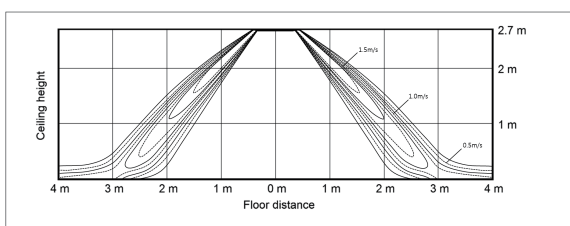

Cooling temperature distribution

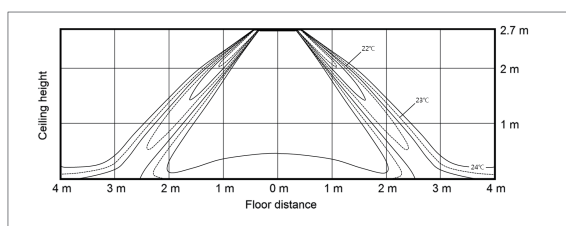

Heating Air Velocity distribution

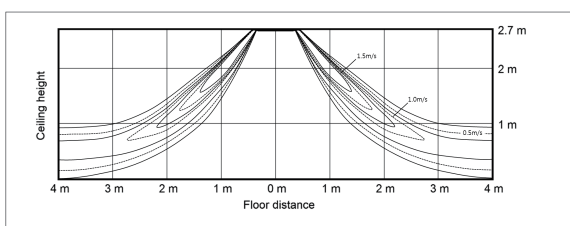

Heating temperature distribution

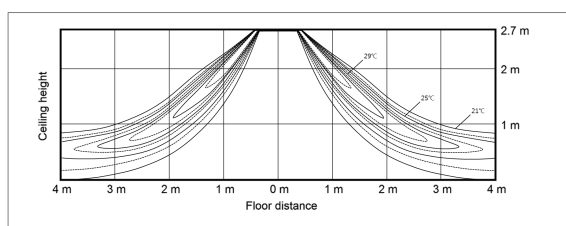

Discharge angle : 52

8. Temperature and Airflow Distribution

4Way Cassette

• AG090MN4DKH/EU

Discharge angle : 45

Cooling Air Velocity distribution

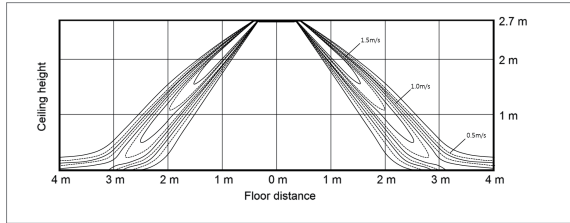

Cooling temperature distribution

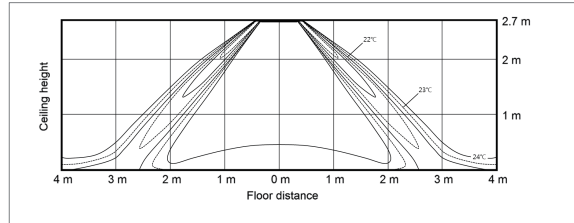

Heating Air Velocity distribution

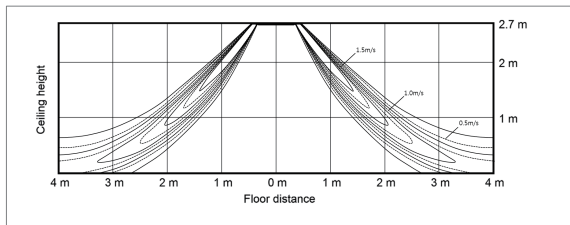

Heating temperature distribution

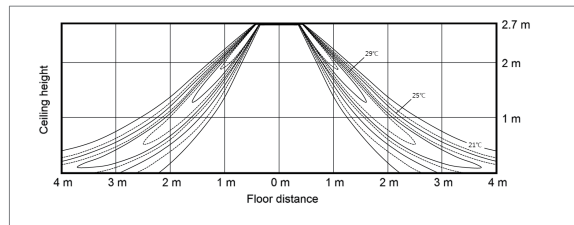

Discharge angle : 52

• AG105MN4DKH/EU

Discharge angle : 45

Cooling Air Velocity distribution

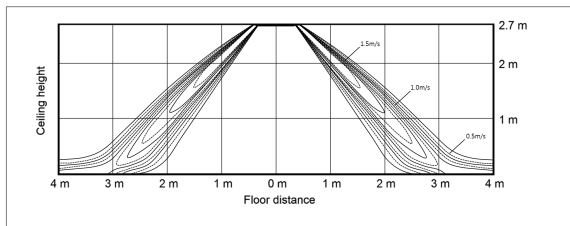

Cooling temperature distribution

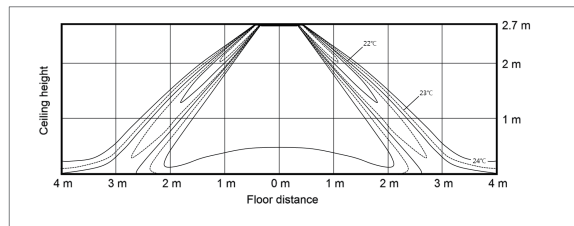

Heating Air Velocity distribution

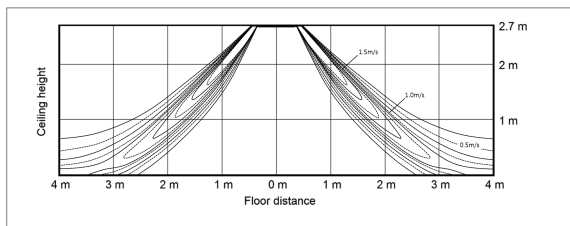

Heating temperature distribution

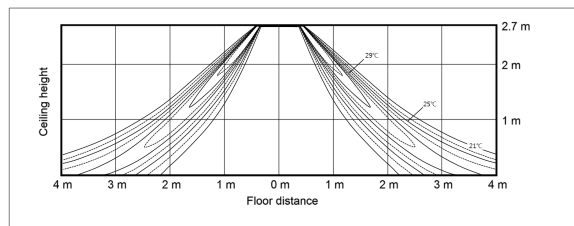

Discharge angle : 52

8. Temperature and Airflow Distribution

360 Cassette

• AG060MN4PKH/EU

Discharge angle : 60

Cooling Air Velocity distribution

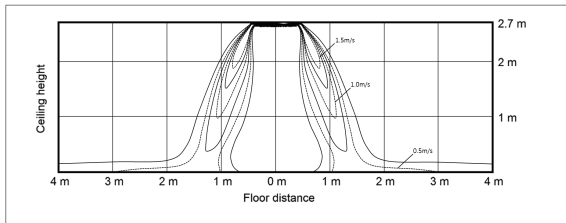

Cooling temperature distribution

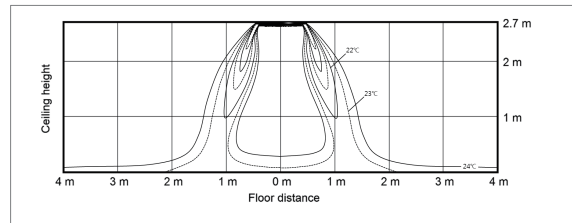

Heating Air Velocity distribution

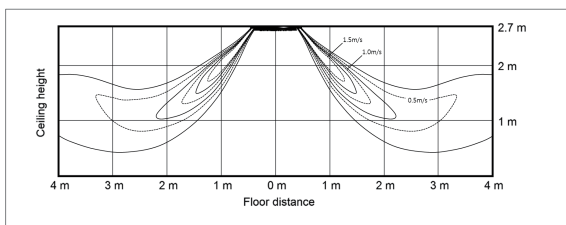

Heating temperature distribution

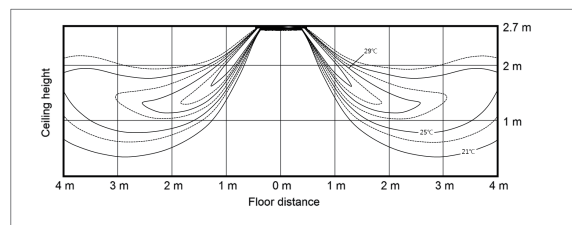

• AG072MN4PKH/EU

Discharge angle : 60

Cooling Air Velocity distribution

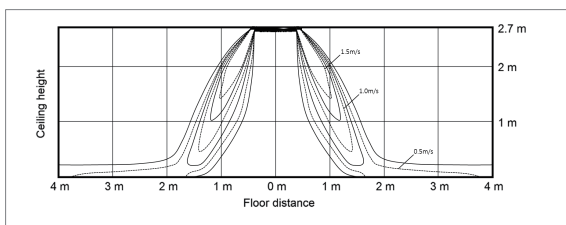

Cooling temperature distribution

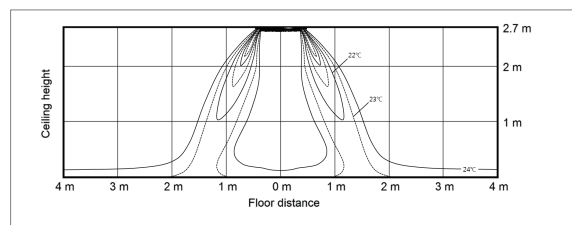

Heating Air Velocity distribution

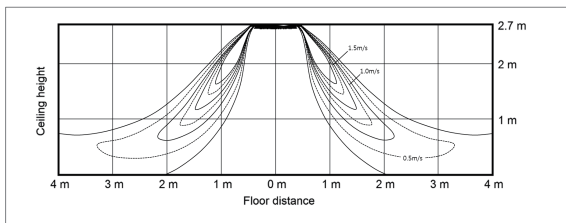

Heating temperature distribution

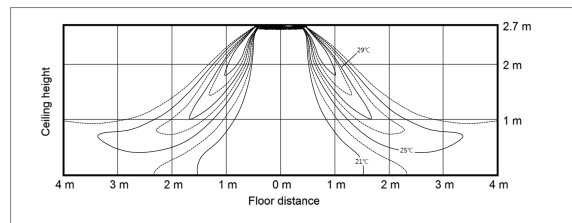

8. Temperature and Airflow Distribution

360 Cassette

• AG090MN4PKH/EU

Discharge angle : 60

Cooling Air Velocity distribution

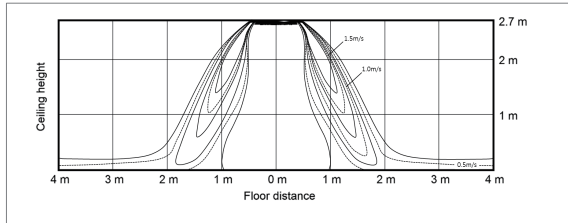

Cooling temperature distribution

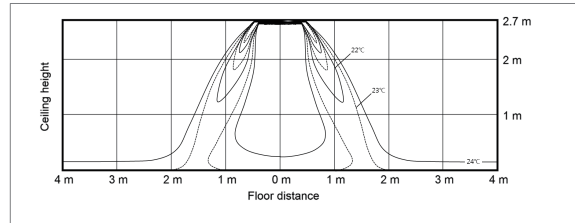

Heating Air Velocity distribution

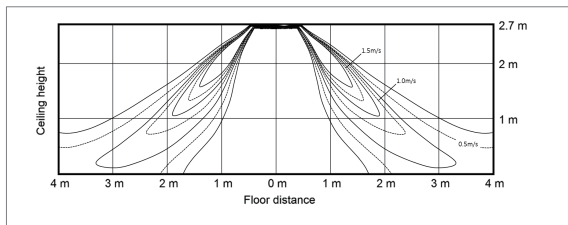

Heating temperature distribution

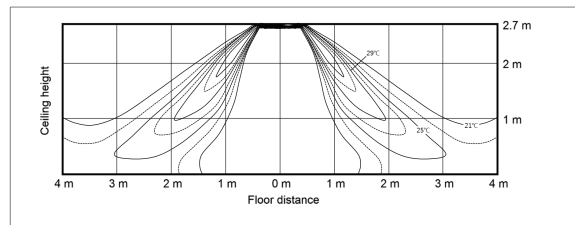

• AG105MN4PKH/EU

Discharge angle : 60

Cooling Air Velocity distribution

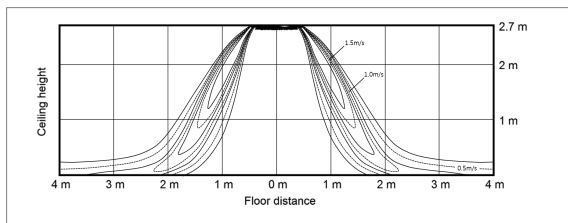

Cooling temperature distribution

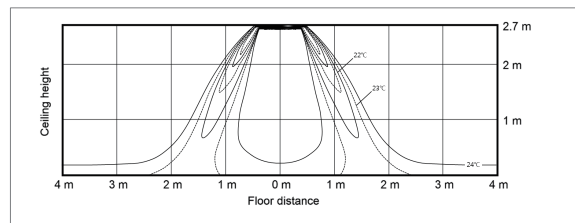

Heating Air Velocity distribution

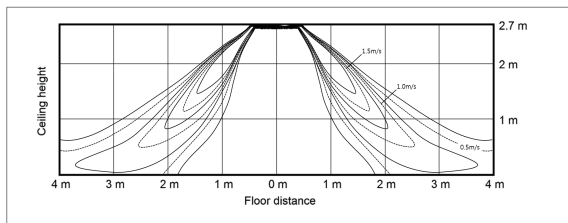

Heating temperature distribution

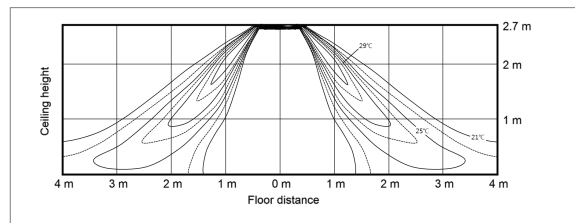

9. Piping Diagram

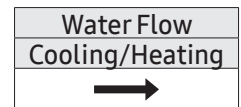
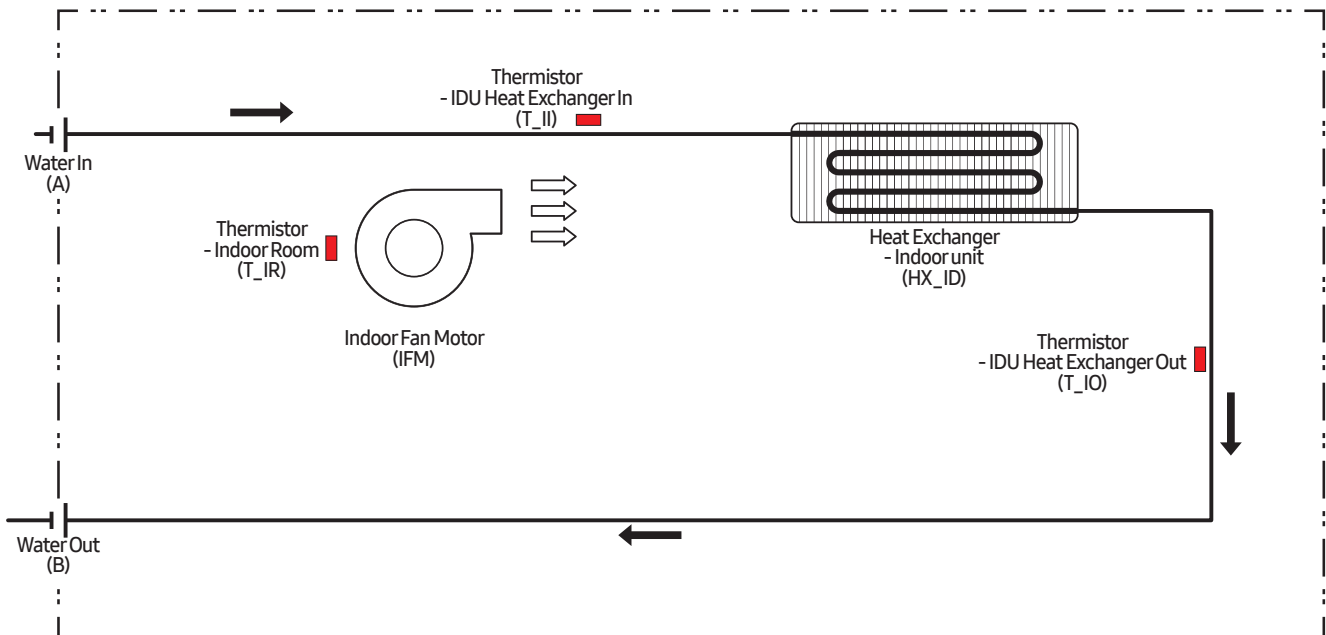

Units : mm (Inches)

Medel		Water pipe	
		A	B
1Way	AG026MN1DEH/EU	20A(3/4")	20A(3/4")
	AG032MN1DEH/EU	20A(3/4")	20A(3/4")
	AG042MN1DEH/EU	20A(3/4")	20A(3/4")
4Way	AG060MN4DKH/EU	20A(3/4")	20A(3/4")
	AG072MN4DKH/EU	20A(3/4")	20A(3/4")
	AG090MN4DKH/EU	20A(3/4")	20A(3/4")
	AG105MN4DKH/EU	20A(3/4")	20A(3/4")
360	AG060MN4PKH/EU	20A(3/4")	20A(3/4")
	AG072MN4PKH/EU	20A(3/4")	20A(3/4")
	AG090MN4PKH/EU	20A(3/4")	20A(3/4")
	AG105MN4PKH/EU	20A(3/4")	20A(3/4")

10. Installation

Step 1. Choosing the installation location

Installation location requirements.

- Air must be distributed optimally.
- The passage of air must not be disturbed.
- Condensation water must be drained easily.
- The support structure must be strong enough to support the weight of the fan coil unit. (If the structure is not strong, the fan coil unit may fall off, leading to personal injury.)
- The ceiling must not be significantly sloped.
- There must be a sufficient space for maintenance and service.
- The power and communication cables of the fan coil unit must be at least 1 m away from electronic appliances such as televisions. (Occasionally, more distance may be required.)

Reinforcing the ceiling

Make sure that the ceiling is sufficient to support the weight of the fan coil unit. If dangerous, reinforce the ceiling with foundation bolts before installing the fan coil unit.

Spacing requirements

- For the cassette type

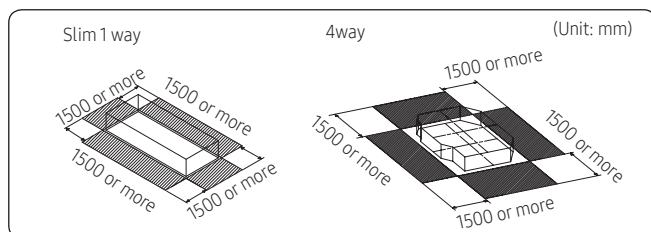

- 360 cassette type

Make sure that the distance between the air inlet and outlet and the obstacle is 1500 mm or more.

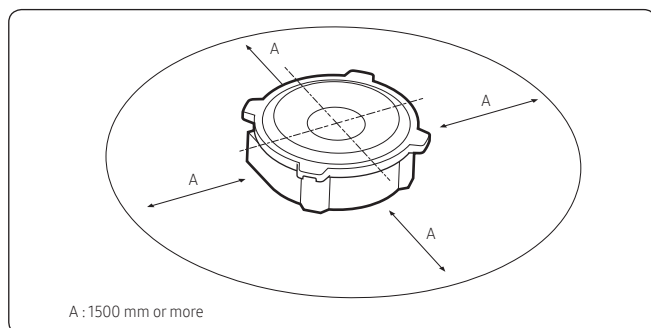

NOTE

- The default installation type for the circular panel is the open type, that is, the panel is not recessed in the ceiling but exposed from the ceiling. For convenient installation and maintenance, secure inspection holes as follows: (The size of each inspection hole must be at least 450 mm × 450 mm.)

- The detachable ceiling structure can replace the inspection holes.

Category	Inspection hole		
	Ceiling type		Open type
	Integrated	Detachable	
Square panel	1 EA	-	
Circular panel	2 EA		

For installing a ceiling type circular panel

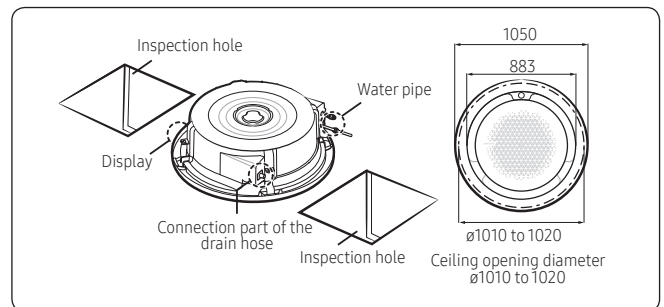

Step 2. Installing the fan coil unit

Preparations for installation

The piping that will be connected to the fan coil unit must be completed before installation.

- 1 Check the product to install and its installation location.
- 2 Check the following installation requirements:
 - When the product is installed on the ceiling, check the strength of the ceiling first.
 - When the product is installed on the ceiling, use the pattern sheet.
 - After making the mounting hole on the ceiling, keep the ceiling surface level.
 - You may need to reinforce the ceiling to prevent the product from causing the upper floor to vibrate.
- 3 Drill holes on the ceiling or the ceiling support, and then insert the foundation bolts, as shown in the following figure:
 - Use bolts of $\varnothing 9.52$ or M10 size and of 1.5 m or less length.
 - Install at least four foundation bolts so that the fan coil unit can be fixed firmly.
 - When the existing ceilings require reinforcement, use anchor holes.
 - For new ceilings, use sunken inserts, sunken anchors, or other commercially available parts.

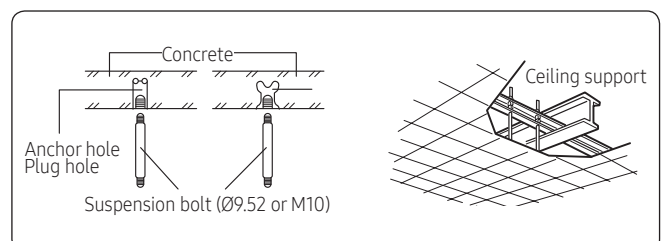

10. Installation

⚠ CAUTION

- Purchase all the needed parts from the market.
- Because the pattern sheet is made of paper, it may shrink or stretch slightly due to temperature or humidity. Therefore, before drilling holes on the ceiling, be sure to check the correct dimensions.
- Be sure to secure a sufficient space that allows for access for maintenance or repairs.

Installing on a new ceiling

- 1 Place the pattern sheet on the ceiling at the spot where you want to install the fan coil unit.

📄 NOTE

- Because the pattern sheet is made of paper, it may shrink or stretch slightly due to temperature or humidity.

Slim 1 way cassette / 4 way cassette

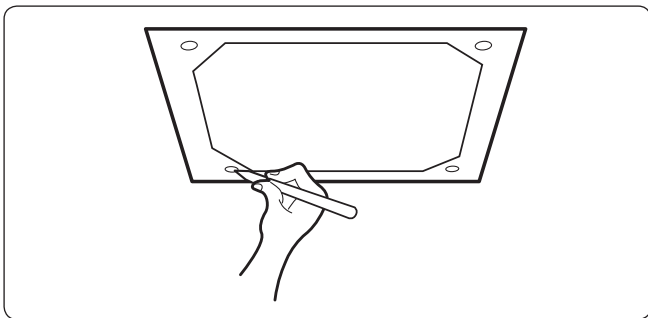

360 cassette

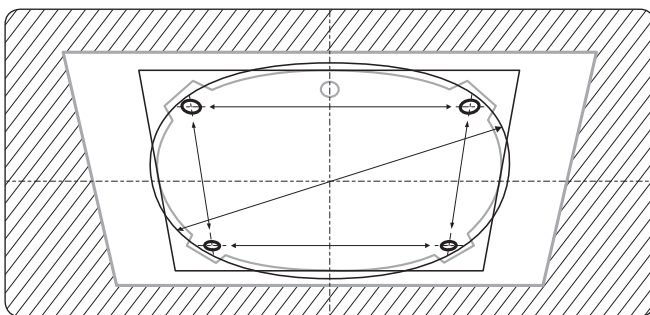

Take the following steps to install one or more inspection holes according to the panel type.

- For installing a ceiling type square panel
Install an inspection hole along the direction of connection parts of the water pipe and the drain hose. (1 point)

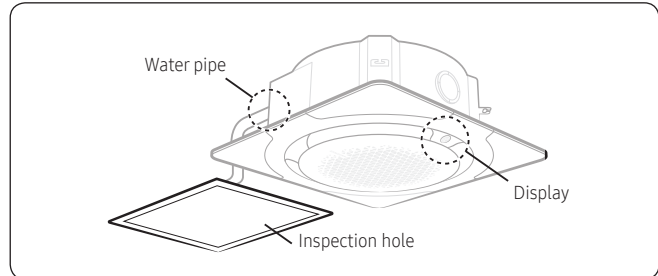

- For installing a ceiling type circular panel
Install an inspection hole along direction of the connection parts of the water pipe and the drain hose and another along the direction of the fan coil unit display. (2 points)

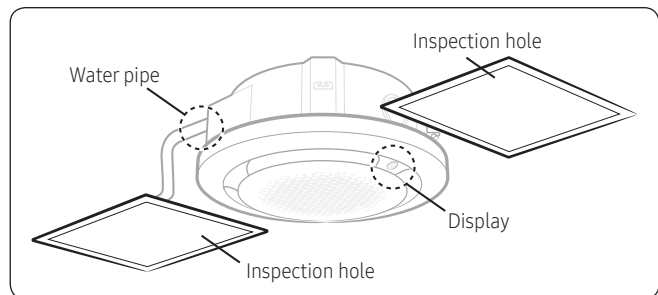

- 2 Drill holes on the ceiling or the ceiling support, and then insert the foundation bolts, as shown in the following figure:

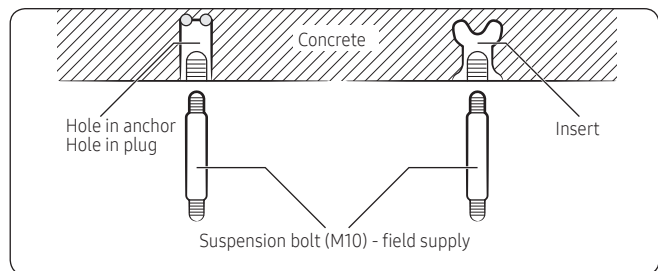

- 3 Install suspension bolts, depending on the ceiling conditions.
 - Before hanging the fan coil unit, make sure that the ceiling is strong enough to support the weight of the unit. Test the strength of each suspension bolt installed.
 - Install the suspension bolts in various ways suitable for the type and material of the ceiling. Anti-vibration treatment is required when the ceiling fixing bolt is 1.5 m or more.

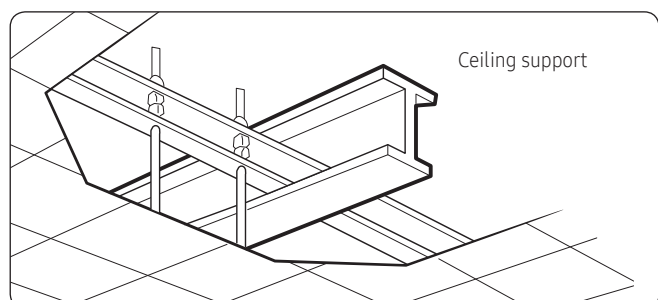

10. Installation

Step 3. Installing the water pipes

1 Remove the caps from the water pipe inlet and outlet.

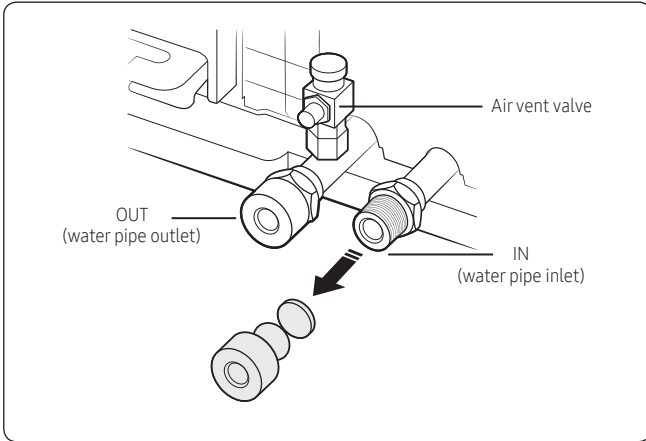

2 Be sure to check the positions of the water pipe inlet and outlet of the fan coil unit by finding their labels (IN and OUT) attached.

- The water pipe inlet label is printed with IN and the water pipe outlet label with OUT.
- Note that the air vent valve is attached to the side where you can find the water pipe outlet.

Category	Slim 1 way	4 way	360
Appearance			

⚠ CAUTION

- Failure to connect the water pipes may cause performance degradation.
 - Be sure to insulate both the inlet and outlet pipings.
- 3 Before connecting the water pipes, be sure to install a 2-way electric valve.
- Be sure to install the 2-way electric valve on the inlet side pipe.
 - When circulating cold/hot water, open the air vent valve and use a tube to receive water so that the air inside the pipe and coil is sufficiently removed, and then close the valve. Failure to do so may cause performance degradation and noise.
 - Before connecting the water pipes, check if the water pipe socket (PF 3/4 ") specification is correct. After connecting the water pipes, remove foreign objects from them, and then circulate water to check for water leakage.

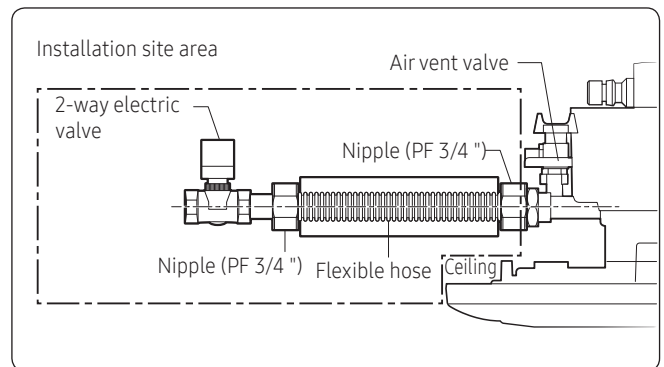

⚠ CAUTION

- Be sure to install a 2-way electric valve on the water pipe inlet of the fan coil unit. Failure to do so may cause condensation and product malfunction.
 - Attach a 40 mesh strainer to the inlet piping (Installation site area)
 - If there is no strainer installed, foreign objects may enter the pipe, causing malfunction and performance degradation to the 2-way electric valve, condensation, or water leakage, etc.
 - When the temperature of intake water is higher than 65 °C, the protection control of the product may be activated.
 - If the outside temperature is lower than 0 °C during winter, the inside of the heat exchanger may freeze and burst. To prevent this, operate a water pump and operate the product to open the 2-way electric valve.
 - When the product is not used for a long period of time in winter, drain all the water from the heat exchanger and the entire water piping system.
 - Use frost preventive additives to prevent the circulating water from freezing in winter.
 - Check if the rated flow rate is being supplied. Low flow rates may cause performance degradation or product malfunction.
- 4 Wind Teflon tape (10 to 15 times) around the threads of the water pipe inlet/outlet sockets of the fan coil unit in the thread direction.

⚠ CAUTION

- When connecting the pipes, tighten sufficiently with a monkey wrench and a torque wrench as shown in the figure above. Failure to do so may cause water leakage.
- When operating the product for the first time or restarting it after a long period of stoppage, open the air vent valve of the heat exchanger and use a tube to receive water so that the air inside the pipe and coil is sufficiently removed, and then close the valve.

10. Installation

5 Manage water quality in accordance with the following water quality standards for refrigeration equipment:

⚠ CAUTION

- If water quality is not managed in accordance with the water quality standards, corrosion and scales may develop, which may shorten the life of the product and cause performance degradation and lead to a serious product malfunction.

	Item	Cold water	Corrosion	Scales
Reference value	PH(25°C)	6.5-8.0	0	-
	Conductivity (25 °C, $\mu\text{S}/\text{cm}$)	200 or less	0	-
	Alkalinity (PPM)	50 or less	-	0
	Hardness (PPM)	50 or less	-	0
	Chlorine ion (PPM)	50 or less	0	-
	Sulfate ion (PPM)	50 or less	0	-
	Iron (PPM)	0.3 or less	0	-
	Sulfur ion (PPM)	Not detected	0	-
	Ammonium ion (PPM)	0.2 or less	0	-
	Silica (PPM)	30 or less	-	0

6 Check the rated flow rate of cold / hot water and the pressure loss inside the heat exchanger.

⚠ CAUTION

- If the rated flow rate is not supplied, it may cause performance degradation and product malfunction.

Category	Mode	Rated flow (LPM)	Pressure loss (kPa)
Slim 1 way cassette	AG026*N1DEH*	7.5	23.0
	AG032*N1DEH*	9.6	34.5
	AG042*N1DEH*	11.9	45.0
4 way cassette	AG060*N4DKH*	17.5	27.0
	AG072*N4DKH*	20.8	36.0
	AG090*N4DKH*	26.0	48.0
	AG105*N4DKH*	30.6	60.7
360 cassette	AG060*N4PKH*	17.5	27.0
	AG072*N4PKH*	20.8	26.0
	AG090*N4PKH*	26.0	38.5
	AG105*N4PKH*	31.8	57.0

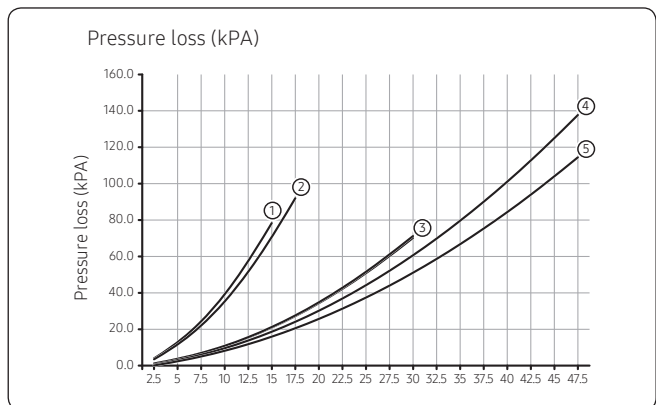

1	Slim 1 way cassette	AG026/032*N1DEH*
2	Slim 1 way cassette	AG042*N1DEH*
3	4 way cassette	AG060/072*N4DKH*
	360 cassette	AG060*N4PKH*
4	4 way cassette	AG090/105*N4DKH*
5	360 cassette	AG072/090/105*N4PKH*

Step 4. Installing the drain pipe

- Drain hoses and PVC pipes are sold separately.
- Before installing the drain pipe, be sure to check if drainage is good.

1 Slide the drain hose all the way into the drain socket

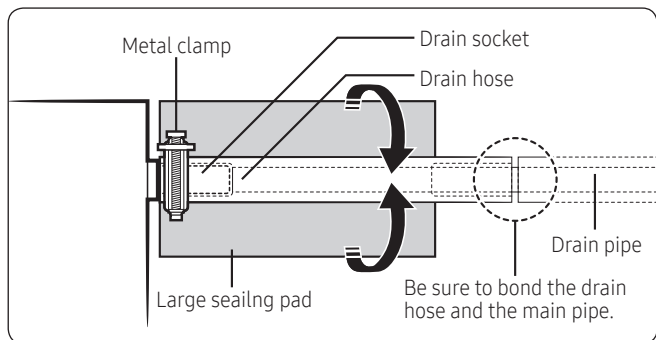

2 Tighten the metal clamp as shown in the figure.

10. Installation

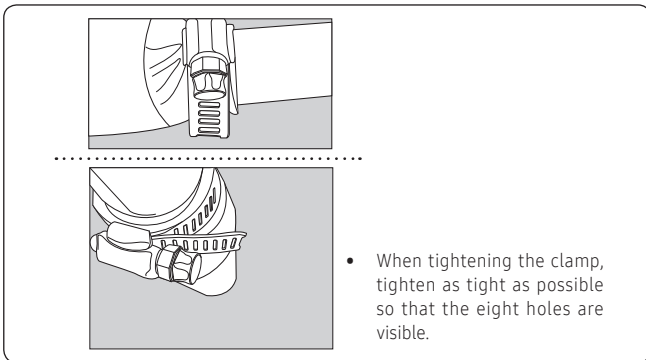

- 3 Wrap the metal clamp and the drain hose with a sealing pad for insulation, and then fix them with a clamp.
- 4 Fully insulate the drain pipe inside the building (on site). If the drain pipe is sloped insufficiently, install the drain pipe vertically from the hose connection port (on site).
- 5 When connecting the drain hose to the drain socket, connect the drain hose by pushing it up.

Individual drainage

Use a leveler to check that the fan coil unit is parallel to the ceiling.

- 1 If the slope of the drain pipe is less than 1/100, be sure to install an air vent at the inlet of each drain hole to smooth the flow of condensation water.
- 2 If the drain pipe is installed higher than the connection port, install the drain pipe vertically within a distance of 300 mm from the flexible hose connection port. (Slim 1 way cassette)
 - However, because the water may leak, the height of the drain pipe should not exceed 550 mm.
- 3 Install the drain pipe at a slope of 1/100 or more.
- 4 Make sure that the distance between the supports is 1 to 1.5 m.
- 5 In order to prevent odor from the outlet of the drain pipe, install a trap at the end of the drain pipe or install an indirect drain.
- 6 Do not apply force to the hose when connecting the drain pipe.
 - Make sure that the hose connection is not loosened and as close as possible to the wall or other support, as shown in the figure.

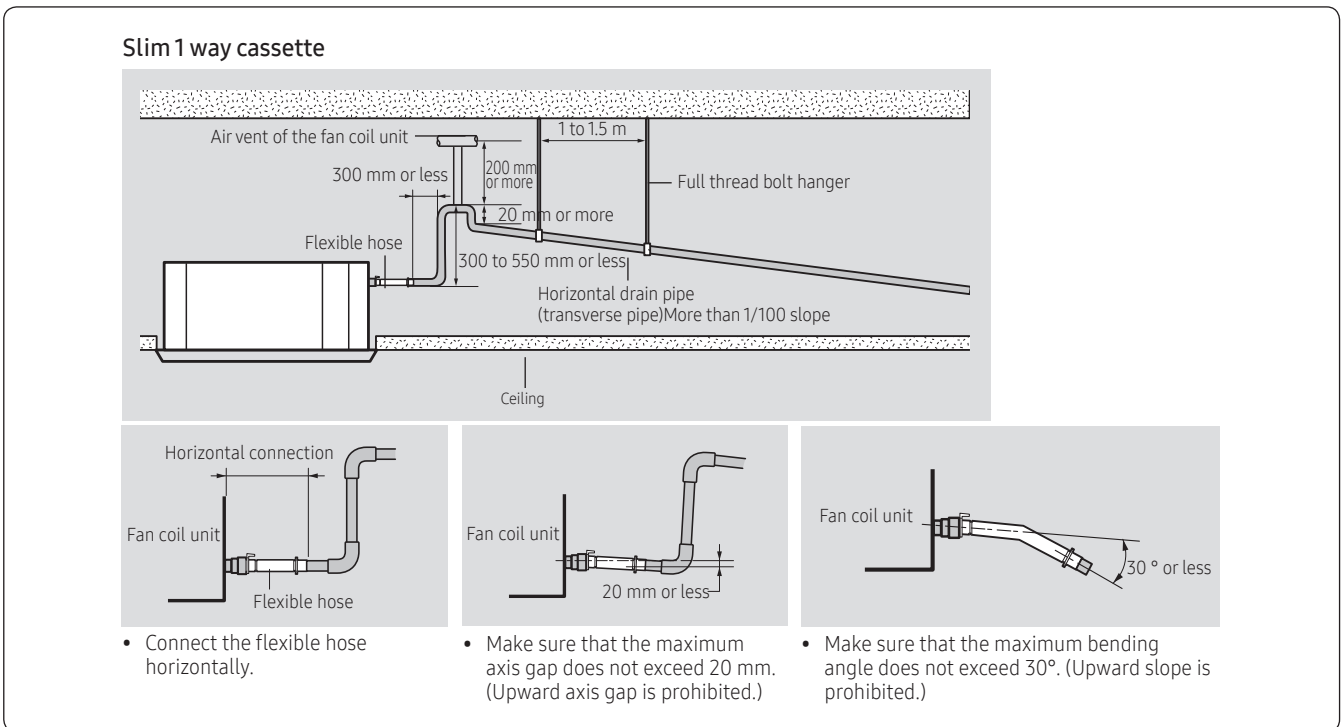

10. Installation

4 way cassette

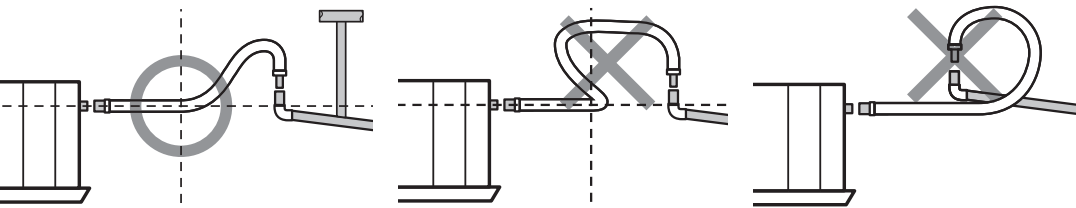
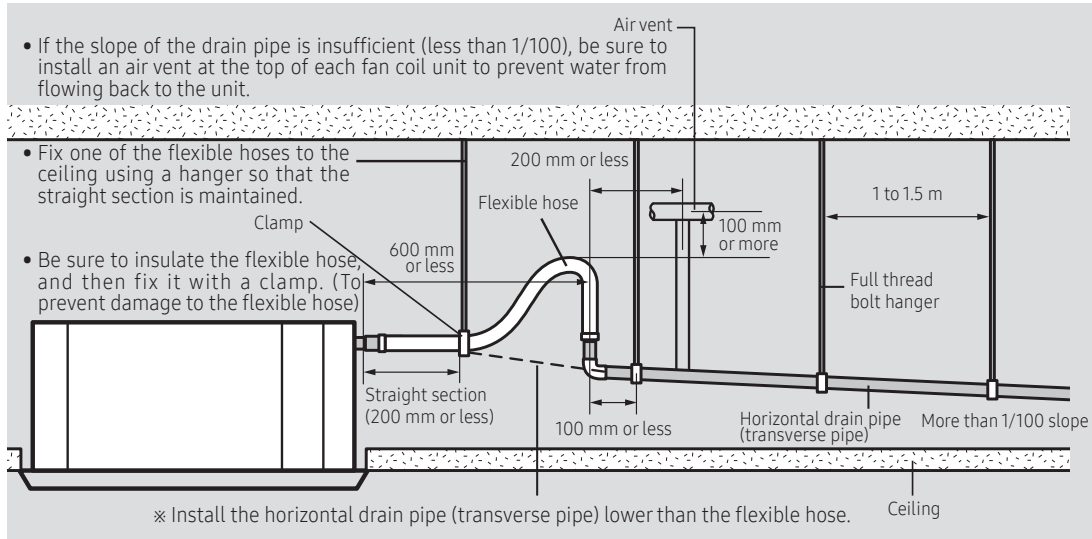

- Do not install the flexible hose in a loop shape, as shown in the figure. The air in the pipe is not smoothly drawn out, causing air pockets and backward flowing of drainage.
- Do not install the flexible hose so that it is bent within 90 degrees, as shown in the figure. (The bent drain hose may degrade drainage performance.)

Concentrated drainage

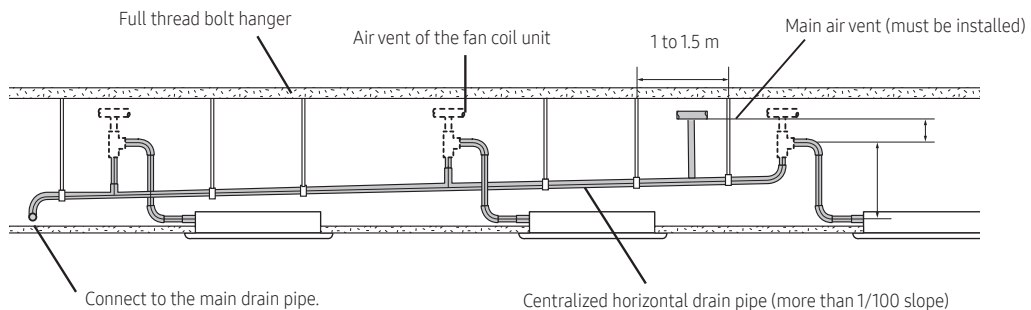

- 1 If 3 or more fan coil units are installed, install the main air vent at the front of the farthest fan coil unit from the main drain pipe.
- 2 If the slope of the centralized horizontal drain pipe is less than 1/100, be sure to install an air vent at the top of each fan coil unit to prevent water from flowing back to the unit.

10. Installation

Step 5. Connecting the drain hose

- 1 Connect the flexible hose to the drain port of the fan coil unit.
 - Make sure that a rubber ring is assembled at the connection port.
 - Securely fasten the flexible hose until you hear “click.”
 - The position of the connection port may differ depending on the fan coil unit model.
- 2 Fix the drain pipe to the opposite end of the flexible hose.
 - Fix the connection port of the flexible hose and the drain pipe (PVC) with adhesive for PVC.
 - After the adhesive for PVC is completely hardened, check whether water leaks from the connection part.
 - Water pipe specifications
 - Slim 1 way cassette (Small): VP20 (OD: $\varnothing 26$, ID: $\varnothing 20$)
 - Slim 1 way cassette (Large)/ 4 way cassette / 360 cassette: VP25 (OD: $\varnothing 32$, ID: $\varnothing 25$)

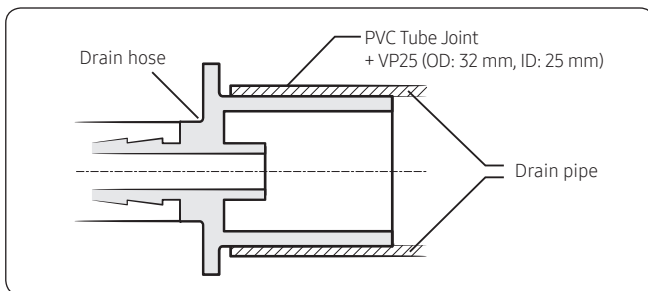
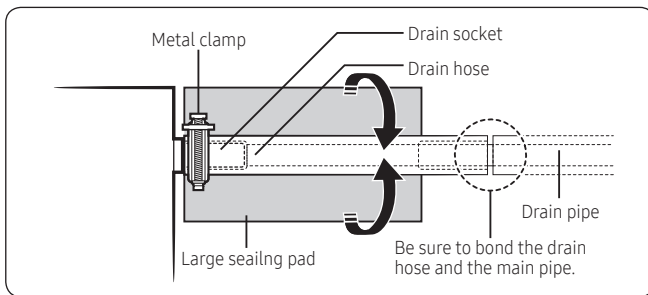

- 3 Shorten the connection length of the drain pipe as much as possible.
 - Install the drain pipe so that it is sloped downward (3 mm or more) for proper drainage of condensation water.
 - Use a cable tie to secure the connection part so that the flexible hose and the drain pipe are not separated.

⚠ CAUTION

- After installing the fan coil unit, be sure to insulate the pipe, piping connections, and drain pipe.

- 4 Wrap the metal clamp and the drain hose with insulation, and then fix them with a clamp.
- 5 Fully insulate the drain pipe inside the building (on site). If the drain pipe is sloped insufficiently, install the drain pipe vertically from the hose connection port (on site).

⚠ CAUTION

- When connecting the flexible hose to the main drain pipe, make sure that the elbow is installed vertically. (Horizontal installation is prohibited.)

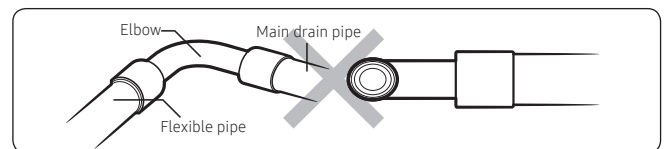
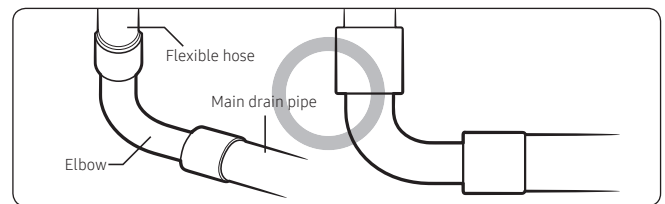

- 6 Remove the accessory vinyl attached to the drain pan. Connect the air vent hose, and then secure it with a cable tie so that it does not come out.

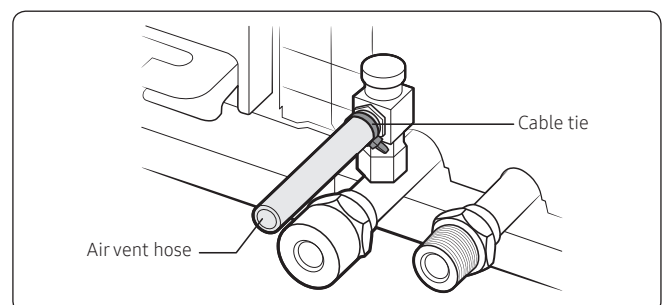
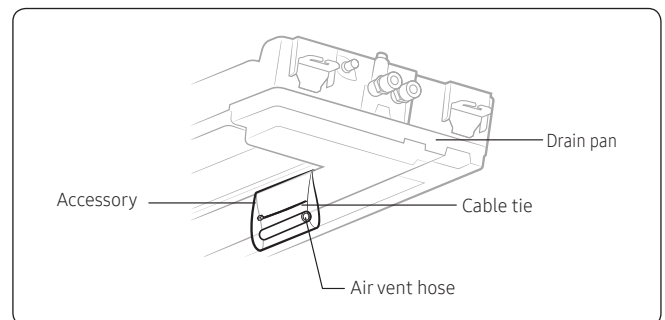

10. Installation

Step 6. Connecting the power and communication cables

1 Power and communication cable connection

- Before wiring work, you must turn off all power source.
- Connect the power and communication cables between the fan coil units in the electrical panel within maximum length so that the voltage drop is under 10%.
- Install an auxiliary circuit breaker (ELCB, MCCB, ELB) with sufficient capacity by considering the number of fan coil units to be connected to it.
- Connect F3 and F4 of the fan coil unit terminal block to the communication cable of the wired remote control.
- Tighten the electric wires with a proper tool within the torque limit to connect and fix them firmly, and then organize the wires to prevent outside pressure being exerted on the covers and other parts.
Failure to do so may result in overheating, electric shock, and fire.
- To protect the product from water and possible shock, you should keep the power and the communication cables in an iron pipe.
- Connect the power cable to the auxiliary circuit breaker (ELCB, MCCB, ELB).
- Keep a distance of 50 mm or more^{mm} between the power cable and the communication cable.

Torque limit (N·m)	
M3	0.5~0.75
M3.5	0.8~1.2
M4	1.2~1.8

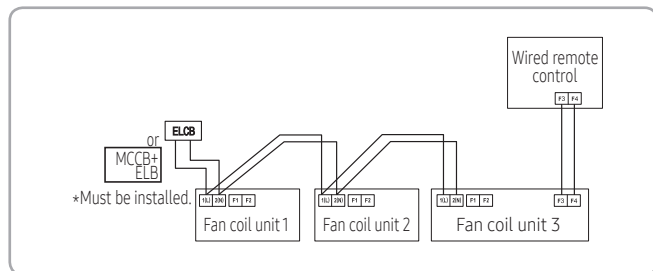

⚠ CAUTION

- The circuit diagram given above shows only wiring schematic, and the details of the actual installation are not presented.
 - The standard specification is that the power supply for the fan coil unit should be separate from that for a heat source such as a chiller.
 - Never branch the terminal block power supply cable from one fan coil unit to two fan coil units.
 - When peeling the power cable, use a special tool for it to prevent damage to the inner sheaths.
 - Make sure that more than 20 mm of the outer sheaths of the fan coil unit's power and communication cables are inserted inside the electrical part.
 - Separate each communication cable from the power cable and other communication cables.
 - When wiring, make sure that the connecting wire is loosened properly.
- ### 2 Selecting the crimping terminal lug
- Select the crimping terminal lug based on the nominal cross-sectional size of the power cable.
 - Cover the connection part of the power cable and the crimping terminal lug to insulate it.

10. Installation

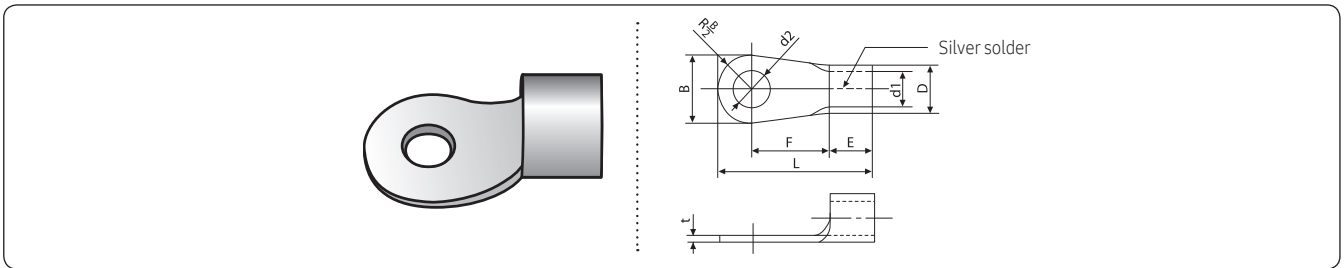

Nominal cross-sectional size	Nominal diameter of thread	B		D		d1		E	F	L	d2		t
		Basic size	Tolerance	Basic size	Tolerance	Basic size	Tolerance				Basic size	Tolerance	
1.5	4	6.6	±0.2	3.4	+0.3 -0.2	1.7	±0.2	4.1	6	16	4.3	+0.2 0	0.7
	4	8											
2.5	4	6.6	±0.2	4.2	+0.3 -0.2	2.3	±0.2	6	6	17.5	4.3	+0.2 0	0.8
	4	8.5											
4	4	9.5	±0.2	5.6	+0.3 -0.2	3.4	±0.2	6	5	20	4.3	+0.2 0	0.9

3 Specifications of the terminal blocks

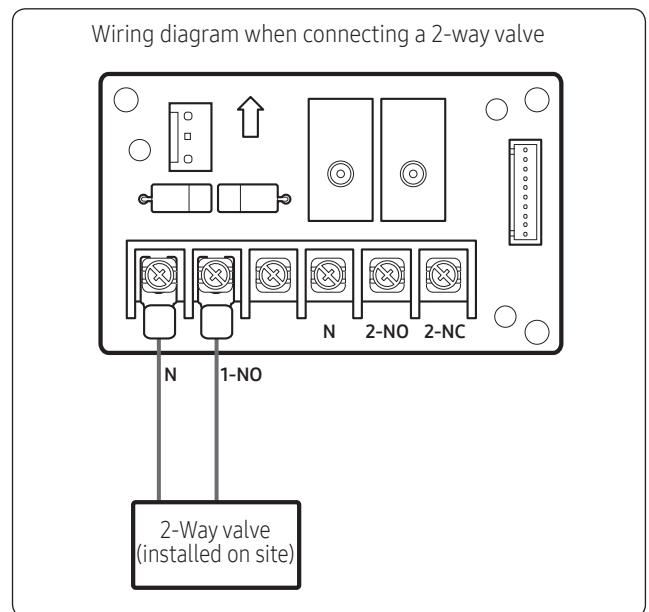
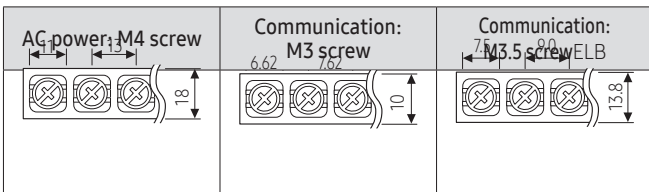

⚠ CAUTION

- When installing the product, be sure to install a 2-way electric valve on the water inlet pipe.
When connecting a 2-way electric valve, be sure to check the correct sub PBA terminals as shown in the figure below.
Incorrect terminal connection may cause product malfunction.
(Valve: Purchased at site)
 - Specification: AC 220 to 240V, 50 Hz (Operating current must be 0.3A or less.)
 - Applicable type: ON / OFF startup contact
- The standard specification is that the power supply for the fan coil unit should be separate from that for a heat source such as a chiller.

10. Installation

Wiring diagram when connecting a 3-way valve

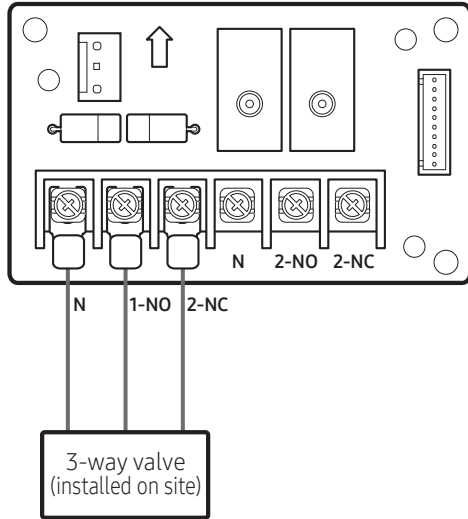

4 Specifications of electrical wiring between fan coil units

Power supply (single phase)	MCCB	ELB	Power cable	Earth wire	Communication cable
220 to 240 V, 50 Hz Min. 198V Max. 264V	XA	XA, 30 mA 0.1 s	2.5 mm ² or more	2.5 mm ²	0.75 to 1.5 mm ²

① Decide the capacity of ELB and MCCB using the following formula.

$$X[A] = 1.25 \times 1.1 \times \sum A_i$$

NOTE

- X: The capacity of ELB, MCCB $\times \sum A_i$: Sum of the rated currents of the fan coil units

Rated currents

Category	Mode	Rated current (A)
Slim 1 way cassette	AG026×N1DEH×	0.24
	AG032×N1DEH×	0.26
	AG042×N1DEH×	0.29
4 way cassette	AG060×N4DKH×	0.37
	AG072×N4DKH×	0.50
	AG090×N4DKH×	0.58
	AG105×N4DKH×	0.79
360 cassette	AG060×N4PKH×	0.41
	AG072×N4PKH×	0.41
	AG090×N4PKH×	0.62
	AG105×N4PKH×	0.79

② Select the cable thickness and wiring length so that the total voltage drop between the fan coil units is less than about 10% of the input voltage (220 V).

$$\sum_{k=1}^n \left(\frac{\text{Coef} \times 35.6 \times L_k}{1000 \times A_k} \times i_k \right) < 10\% \text{ of input voltage [V]}$$

※ coef: Approximately 1.55 in consideration of the contact resistance when the wire is fastened to the terminal

※ L_k: Distance between fan coil units [m], A_k: Thickness of the power cable [mm²] i_k: Current between fan coil units [A]

10. Installation

Installation example

Total power cable length L = 100 [m], initial pull-in current i = 10 [A], running current of each unit = 1 [A], total 10 fan coil units are installed

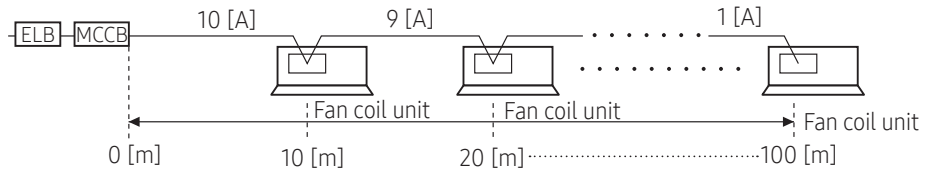

> Apply the following formula.

$$\sum_{k=1}^n \left(\frac{\text{Coef} \times 35.6 \times L_k \times i_k}{1000 \times A_k} \right) < 10\% \text{ of input voltage [V]}$$

> Calculation

- Installing with one type of wire

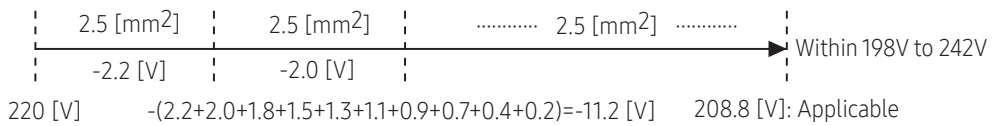

- Installing with two types of wires

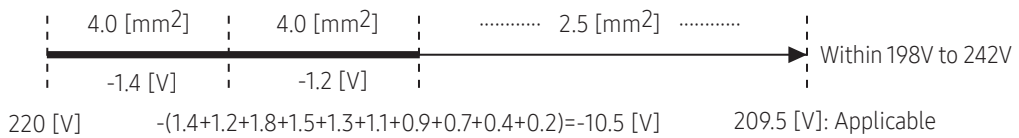

※ Appendix : Capacity Table

1 Way Cassette

Cooling

※ Total Capacity (kW) / Sensible Capacity (kW) / Water Flow (ℓ/min) / ΔP (kPa)

AG026MN1DEH/EU																
Air temperature (DB°C - WB°C)	24-17															
Water In (°C)-Out (°C)	6-11				6-13				7-12				9-14			
Air flow	Total capacity	Sensible	Water Flow	ΔP	Total capacity	Sensible	Water Flow	ΔP	Total capacity	Sensible	Water Flow	ΔP	Total capacity	Sensible	Water Flow	ΔP
H	2.21	1.79	6.3	17.7	1.78	1.59	3.6	7.4	1.98	1.69	5.7	14.8	1.57	1.47	4.5	10.3
M	1.98	1.58	5.7	14.8	1.59	1.40	3.3	6.3	1.77	1.49	5.1	12.4	1.40	1.30	4.0	8.7
L	1.76	1.39	5.0	12.3	1.41	1.22	2.9	5.3	1.57	1.31	4.5	10.3	1.25	1.14	3.6	7.3
Air temperature (DB°C - WB°C)	25-18.7															
Water In (°C)-Out (°C)	6-11				6-13				7-12				9-14			
Air flow	Total capacity	Sensible	Water Flow	ΔP	Total capacity	Sensible	Water Flow	ΔP	Total capacity	Sensible	Water Flow	ΔP	Total capacity	Sensible	Water Flow	ΔP
H	2.75	1.86	7.9	25.3	2.19	1.65	4.5	10.2	2.41	1.74	6.9	20.4	1.87	1.52	5.3	13.5
M	2.46	1.63	7.0	21.0	1.96	1.45	4.0	8.6	2.16	1.53	6.2	17.0	1.67	1.33	4.8	11.3
L	2.18	1.44	6.3	17.3	1.74	1.26	3.6	7.2	1.92	1.35	5.5	14.0	1.48	1.16	4.3	9.4
Air temperature (DB°C - WB°C)	27-19.5															
Water In (°C)-Out (°C)	6-11				6-13				7-12				9-14			
Air flow	Total capacity	Sensible	Water Flow	ΔP	Total capacity	Sensible	Water Flow	ΔP	Total capacity	Sensible	Water Flow	ΔP	Total capacity	Sensible	Water Flow	ΔP
H	3.08	2.12	8.8	30.6	2.43	1.86	5.0	12.0	2.60	1.93	7.5	23.1	2.17	1.78	6.2	17.1
M	2.75	1.86	7.9	25.4	2.17	1.63	4.4	10.1	2.33	1.70	6.7	19.2	1.94	1.56	5.6	14.3
L	2.45	1.63	7.0	20.8	1.93	1.43	4.0	8.4	2.07	1.49	5.9	15.9	1.72	1.37	4.9	11.9
Air temperature (DB°C - WB°C)	27-21															
Water In (°C)-Out (°C)	6-11				6-13				7-12				9-14			
Air flow	Total capacity	Sensible	Water Flow	ΔP	Total capacity	Sensible	Water Flow	ΔP	Total capacity	Sensible	Water Flow	ΔP	Total capacity	Sensible	Water Flow	ΔP
H	3.67	2.13	10.5	41.6	2.97	1.84	6.1	16.5	3.26	1.99	9.4	33.9	2.67	1.75	7.7	24.2
M	3.29	1.88	9.4	34.3	2.65	1.63	5.4	13.8	2.92	1.75	8.4	28.0	2.39	1.55	6.9	20.1
L	2.92	1.66	8.4	28.1	2.36	1.44	4.8	11.5	2.60	1.51	7.4	23.0	2.13	1.37	6.1	16.6

AG032MN1DEH/EU																
Air temperature (DB°C - WB°C)	24-17															
Water In (°C)-Out (°C)	6-11				6-13				7-12				9-14			
Air flow	Total capacity (kW)	Sensible (kW)	Water Flow (ℓ/min)	ΔP (kPa)	Total capacity	Sensible	Water Flow	ΔP	Total capacity	Sensible	Water Flow	ΔP	Total capacity	Sensible	Water Flow	ΔP
H	3.05	2.42	8.7	30.2	2.46	2.17	5.0	12.3	2.73	2.29	7.8	25.1	2.18	2.01	6.3	17.3
M	2.77	2.17	7.9	25.6	2.24	1.94	4.6	10.6	2.48	2.05	7.1	21.4	1.98	1.81	5.7	14.8
L	2.20	1.71	6.3	17.6	1.78	1.51	3.6	7.5	1.97	1.61	5.7	14.7	1.58	1.42	4.5	10.3
Air temperature (DB°C - WB°C)	25-18.7															
Water In (°C)-Out (°C)	6-11				6-13				7-12				9-14			
Air flow	Total capacity	Sensible	Water Flow	ΔP	Total capacity	Sensible	Water Flow	ΔP	Total capacity	Sensible	Water Flow	ΔP	Total capacity	Sensible	Water Flow	ΔP
H	3.77	2.50	10.8	43.4	3.02	2.23	6.2	17.0	3.32	2.35	9.5	34.8	2.58	2.06	7.4	22.8
M	3.42	2.22	9.8	36.7	2.74	1.98	5.6	14.6	3.01	2.09	8.6	29.5	2.34	1.84	6.7	19.5
L	2.72	1.75	7.8	24.9	2.18	1.55	4.5	10.2	2.39	1.65	6.9	20.1	1.86	1.43	5.3	13.4
Air temperature (DB°C - WB°C)	27-19.5															
Water In (°C)-Out (°C)	6-11				6-13				7-12				9-14			
Air flow	Total capacity	Sensible	Water Flow	ΔP	Total capacity	Sensible	Water Flow	ΔP	Total capacity	Sensible	Water Flow	ΔP	Total capacity	Sensible	Water Flow	ΔP
H	4.21	2.84	12.1	52.7	3.34	2.50	6.8	20.0	3.50	2.55	10.0	38.2	2.99	2.40	8.6	29.1
M	3.82	2.53	11.0	44.5	3.03	2.24	6.2	17.1	3.18	2.28	9.1	32.4	2.71	2.15	7.8	24.8
L	3.04	1.98	8.7	30.0	2.41	1.75	4.9	11.9	2.53	1.78	7.2	22.0	2.16	1.69	6.2	17.0
Air temperature (DB°C - WB°C)	27-21															
Water In (°C)-Out (°C)	6-11				6-13				7-12				9-14			
Air flow	Total capacity	Sensible	Water Flow	ΔP	Total capacity	Sensible	Water Flow	ΔP	Total capacity	Sensible	Water Flow	ΔP	Total capacity	Sensible	Water Flow	ΔP
H	5.02	2.83	14.4	72.0	4.06	2.46	8.3	27.7	4.47	2.65	12.8	58.5	3.67	2.35	10.5	41.5
M	4.56	2.54	13.1	60.6	3.69	2.22	7.6	23.6	4.06	2.37	11.6	49.4	3.33	2.11	9.6	35.1
L	3.62	2.00	10.4	40.5	2.93	1.75	6.0	16.2	3.22	1.83	9.2	33.2	2.65	1.67	7.6	23.8

※ Appendix : Capacity Table

1 Way Cassette

Cooling

※ Total Capacity (kW) / Sensible Capacity (kW) / Water Flow (ℓ/min) / ΔP (kPa)

AG042MN1DEH/EU																
Air temperature (DB°C - WB°C) 24-17																
Water In (°C)-Out (°C)																
6-11				6-13				7-12				9-14				
Air flow	Total capacity	Sensible	Water Flow	ΔP	Total capacity	Sensible	Water Flow	ΔP	Total capacity	Sensible	Water Flow	ΔP	Total capacity	Sensible	Water Flow	ΔP
H	3.83	2.95	11.0	40.4	3.08	2.64	6.3	16.2	3.42	2.79	9.8	33.4	2.72	2.44	7.8	22.8
M	3.45	2.62	9.9	33.9	2.77	2.34	5.7	13.8	3.09	2.48	8.9	28.1	2.45	2.18	7.0	19.3
L	3.08	2.32	8.8	28.0	2.47	2.05	5.1	11.6	2.75	2.18	7.9	23.3	2.19	1.92	6.3	16.1
Air temperature (DB°C - WB°C) 25-18.7																
Water In (°C)-Out (°C)																
6-11				6-13				7-12				9-14				
Air flow	Total capacity	Sensible	Water Flow	ΔP	Total capacity	Sensible	Water Flow	ΔP	Total capacity	Sensible	Water Flow	ΔP	Total capacity	Sensible	Water Flow	ΔP
H	4.75	3.04	13.6	58.6	3.79	2.71	7.8	22.7	4.17	2.86	12.0	46.7	3.23	2.50	9.3	30.3
M	4.29	2.68	12.3	49.0	3.42	2.40	7.0	19.2	3.76	2.52	10.8	39.2	2.91	2.21	8.3	25.5
L	3.82	2.38	11.0	40.2	3.05	2.09	6.2	16.0	3.36	2.24	9.6	32.3	2.60	1.94	7.4	21.2
Air temperature (DB°C - WB°C) 27-19.5																
Water In (°C)-Out (°C)																
6-11				6-13				7-12				9-14				
Air flow	Total capacity	Sensible	Water Flow	ΔP	Total capacity	Sensible	Water Flow	ΔP	Total capacity	Sensible	Water Flow	ΔP	Total capacity	Sensible	Water Flow	ΔP
H	5.32	3.47	15.3	71.5	4.20	3.06	8.6	26.8	4.50	3.18	12.9	53.3	3.75	2.93	10.7	38.9
M	4.80	3.07	13.8	59.6	3.79	2.71	7.8	22.6	4.06	2.81	11.6	44.6	3.38	2.60	9.7	32.7
L	4.28	2.69	12.3	48.9	3.38	2.38	6.9	18.8	3.62	2.47	10.4	36.7	3.02	2.29	8.6	27.0
Air temperature (DB°C - WB°C) 27-21																
Water In (°C)-Out (°C)																
6-11				6-13				7-12				9-14				
Air flow	Total capacity	Sensible	Water Flow	ΔP	Total capacity	Sensible	Water Flow	ΔP	Total capacity	Sensible	Water Flow	ΔP	Total capacity	Sensible	Water Flow	ΔP
H	6.36	3.44	18.2	98.2	5.13	2.99	10.5	37.5	5.65	3.22	16.2	79.5	4.63	2.85	13.3	55.9
M	5.74	3.07	16.4	81.7	4.63	2.68	9.5	31.5	5.10	2.86	14.6	66.2	4.18	2.55	12.0	46.8
L	5.12	2.71	14.7	66.7	4.13	2.36	8.5	26.0	4.55	2.47	13.0	54.2	3.72	2.25	10.7	38.5

※ Appendix : Capacity Table

1 Way Cassette

Heating

※ Capacity (kW) / Water Flow (ℓ/min) / ΔP (kPa)

AG026MN1DEH/EU															
Air temperature(°C)	18														
Water In(°C)-Out(°C)	45-40			50-45			55-50			55-45			60-50		
Air Flow	Capacity	Water Flow	ΔP	Capacity	Water Flow	ΔP	Capacity	Water Flow	ΔP	Capacity	Water Flow	ΔP	Capacity	Water Flow	ΔP
H	3.10	8.9	30.7	3.50	10.0	38.4	4.09	11.7	50.8	3.74	5.4	12.4	4.43	6.4	17.5
M	2.77	7.9	25.4	3.16	9.1	32.3	3.71	10.6	43.1	3.40	4.9	10.6	3.97	5.7	14.6
L	2.46	7.1	20.9	2.91	8.4	28.2	3.47	10.0	38.8	3.18	4.6	9.5	3.52	5.1	12.1
Air temperature(°C)	20														
Water In(°C)-Out(°C)	45-40			50-45			55-50			55-45			60-50		
Air Flow	Capacity	Water Flow	ΔP	Capacity	Water Flow	ΔP	Capacity	Water Flow	ΔP	Capacity	Water Flow	ΔP	Capacity	Water Flow	ΔP
H	2.90	8.4	28.0	3.31	9.5	34.9	3.83	11.0	45.4	3.51	5.0	11.1	4.19	6.0	16.0
M	2.59	7.4	22.8	2.96	8.5	28.9	3.48	10.0	38.7	3.19	4.6	9.5	3.75	5.4	13.4
L	2.31	6.6	18.7	2.73	7.8	25.4	3.25	9.3	34.8	2.97	4.3	8.5	3.33	4.8	11.1
Air temperature(°C)	22														
Water In(°C)-Out(°C)	45-40			50-45			55-50			55-45			60-50		
Air Flow	Capacity	Water Flow	ΔP	Capacity	Water Flow	ΔP	Capacity	Water Flow	ΔP	Capacity	Water Flow	ΔP	Capacity	Water Flow	ΔP
H	2.55	7.3	22.1	2.90	8.3	28.0	3.36	9.6	36.4	3.08	4.4	8.9	3.93	5.6	14.4
M	2.28	6.5	18.3	2.60	7.5	23.3	3.05	8.8	31.1	2.79	4.0	7.6	3.51	5.0	12.1
L	2.02	5.8	15.1	2.39	6.9	20.5	2.85	8.2	28.1	2.61	3.7	6.9	3.12	4.5	10.0

AG032MN1DEH/EU															
Air temperature(°C)	18														
Water In(°C)-Out(°C)	45-40			50-45			55-50			55-45			60-50		
Air Flow	Capacity	Water Flow	ΔP	Capacity	Water Flow	ΔP	Capacity	Water Flow	ΔP	Capacity	Water Flow	ΔP	Capacity	Water Flow	ΔP
H	3.58	10.3	39.4	4.08	11.7	50.0	4.72	13.5	65.0	4.32	6.2	15.9	5.36	7.7	24.1
M	3.25	9.3	33.4	3.71	10.6	42.4	4.36	12.5	56.8	3.99	5.7	13.9	4.87	7.0	20.5
L	2.59	7.4	22.6	3.36	9.6	36.4	3.98	11.4	49.3	3.58	5.1	11.7	3.87	5.5	14.1
Air temperature(°C)	20														
Water In(°C)-Out(°C)	45-40			50-45			55-50			55-45			60-50		
Air Flow	Capacity	Water Flow	ΔP	Capacity	Water Flow	ΔP	Capacity	Water Flow	ΔP	Capacity	Water Flow	ΔP	Capacity	Water Flow	ΔP
H	3.35	9.7	35.8	3.82	11.0	44.6	4.42	12.7	58.0	4.05	5.8	14.2	5.06	7.3	21.9
M	3.04	8.7	29.8	3.47	10.0	37.8	4.08	11.7	50.7	3.73	5.4	12.4	4.60	6.6	18.6
L	2.42	6.9	20.3	3.15	9.0	32.7	3.72	10.7	44.1	3.31	4.7	10.3	3.66	5.2	12.9
Air temperature(°C)	22														
Water In(°C)-Out(°C)	45-40			50-45			55-50			55-45			60-50		
Air Flow	Capacity	Water Flow	ΔP	Capacity	Water Flow	ΔP	Capacity	Water Flow	ΔP	Capacity	Water Flow	ΔP	Capacity	Water Flow	ΔP
H	2.94	8.4	28.1	3.35	9.6	35.6	3.88	11.1	46.4	3.55	5.1	11.4	4.75	6.8	19.6
M	2.67	7.7	23.9	3.05	8.8	30.4	3.58	10.3	40.6	3.28	4.7	10.0	4.31	6.2	16.8
L	2.12	6.1	16.4	2.76	7.9	26.3	3.27	9.4	35.7	2.99	4.3	8.7	3.43	4.9	11.6

AG042MN1DEH/EU															
Air temperature(°C)	18														
Water In(°C)-Out(°C)	45-40			50-45			55-50			55-45			60-50		
Air Flow	Capacity	Water Flow	ΔP	Capacity	Water Flow	ΔP	Capacity	Water Flow	ΔP	Capacity	Water Flow	ΔP	Capacity	Water Flow	ΔP
H	5.34	15.3	72.0	6.09	17.5	91.4	7.05	20.2	118.9	6.45	9.3	29.1	7.01	10.0	34.8
M	5.02	14.4	64.5	5.72	16.4	81.8	6.72	19.3	109.4	6.09	8.7	26.3	6.58	9.4	31.3
L	4.70	13.5	57.5	5.36	15.4	73.0	6.30	18.1	97.7	5.70	8.2	23.4	6.17	8.8	28.1
Air temperature(°C)	20														
Water In(°C)-Out(°C)	45-40			50-45			55-50			55-45			60-50		
Air Flow	Capacity	Water Flow	ΔP	Capacity	Water Flow	ΔP	Capacity	Water Flow	ΔP	Capacity	Water Flow	ΔP	Capacity	Water Flow	ΔP
H	5.00	14.4	64.6	5.70	16.4	81.3	6.60	18.9	105.9	6.00	8.6	25.6	6.62	9.5	31.6
M	4.70	13.5	57.4	5.35	15.4	72.8	6.29	18.1	97.4	5.63	8.1	22.9	6.22	8.9	28.5
L	4.40	12.6	51.3	5.01	14.4	64.9	5.89	16.9	86.9	5.28	7.6	20.5	5.83	8.3	25.6
Air temperature(°C)	22														
Water In(°C)-Out(°C)	45-40			50-45			55-50			55-45			60-50		
Air Flow	Capacity	Water Flow	ΔP	Capacity	Water Flow	ΔP	Capacity	Water Flow	ΔP	Capacity	Water Flow	ΔP	Capacity	Water Flow	ΔP
H	4.39	12.6	51.1	5.00	14.3	64.7	5.79	16.6	84.3	5.30	7.6	20.6	6.21	8.9	28.4
M	4.12	11.8	45.8	4.70	13.5	58.2	5.52	15.8	77.7	5.05	7.2	19.0	5.83	8.4	25.6
L	3.86	11.1	41.0	4.40	12.6	52.0	5.17	14.8	69.5	4.73	6.8	17.0	5.46	7.8	23.0

※ Appendix : Capacity Table

4 Way Cassette

Cooling

※ Total Capacity (kW) / Sensible Capacity (kW) / Water Flow (ℓ/min) / ΔP (kPa)

AG060MN4DKH/EU																	
Air temperature (DB°C - WB°C)		24-17															
Water In (°C)-Out (°C)		6-11				6-13				7-12				9-14			
Air flow	Total capacity	Sensible	Water Flow	ΔP	Total capacity	Sensible	Water Flow	ΔP	Total capacity	Sensible	Water Flow	ΔP	Total capacity	Sensible	Water Flow	ΔP	
H	5.66	4.50	16.2	23.5	4.57	4.02	9.4	9.2	5.08	4.25	14.5	19.5	4.05	3.74	11.6	13.2	
M	5.15	4.03	14.8	19.9	4.16	3.60	8.5	7.8	4.62	3.81	13.2	16.5	3.69	3.36	10.6	11.3	
L	4.50	3.48	12.9	15.8	3.63	3.09	7.4	6.2	4.03	3.29	11.6	13.1	3.22	2.90	9.2	8.9	
Air temperature (DB°C - WB°C)		25-18.7															
Water In (°C)-Out (°C)		6-11				6-13				7-12				9-14			
Air flow	Total capacity	Sensible	Water Flow	ΔP	Total capacity	Sensible	Water Flow	ΔP	Total capacity	Sensible	Water Flow	ΔP	Total capacity	Sensible	Water Flow	ΔP	
H	6.99	4.64	20.0	34.0	5.61	4.14	11.5	13.0	6.16	4.36	17.6	27.2	4.79	3.82	13.7	17.6	
M	6.36	4.12	18.2	28.8	5.10	3.69	10.4	11.0	5.60	3.88	16.0	23.1	4.36	3.41	12.5	15.0	
L	5.55	3.58	15.9	22.7	4.46	3.16	9.1	8.8	4.89	3.37	14.0	18.2	3.81	2.93	10.9	11.9	
Air temperature (DB°C - WB°C)		27-19.5															
Water In (°C)-Out (°C)		6-11				6-13				7-12				9-14			
Air flow	Total capacity	Sensible	Water Flow	ΔP	Total capacity	Sensible	Water Flow	ΔP	Total capacity	Sensible	Water Flow	ΔP	Total capacity	Sensible	Water Flow	ΔP	
H	7.82	5.27	22.4	41.5	6.20	4.65	12.7	15.4	6.50	4.74	19.0	31.0	5.55	4.46	15.9	22.7	
M	7.11	4.70	20.4	35.0	5.64	4.16	11.5	13.1	5.91	4.23	16.9	25.3	5.04	3.99	14.5	19.2	
L	6.21	4.05	17.8	27.6	4.93	3.58	10.1	10.4	5.16	3.64	14.8	20.0	4.41	3.44	12.6	15.3	
Air temperature (DB°C - WB°C)		27-21															
Water In (°C)-Out (°C)		6-11				6-13				7-12				9-14			
Air flow	Total capacity	Sensible	Water Flow	ΔP	Total capacity	Sensible	Water Flow	ΔP	Total capacity	Sensible	Water Flow	ΔP	Total capacity	Sensible	Water Flow	ΔP	
H	9.32	5.25	26.7	56.8	7.54	4.57	15.4	21.6	8.29	4.92	23.8	46.1	6.82	4.36	19.5	32.5	
M	8.47	4.73	24.3	47.9	6.86	4.12	14.0	18.3	7.54	4.40	21.6	38.9	6.20	3.93	17.8	27.5	
L	7.40	4.09	21.2	37.6	5.99	3.57	12.3	14.5	6.59	3.74	18.9	30.6	5.41	3.40	15.5	21.8	

AG072MN4DKH/EU																	
Air temperature (DB°C - WB°C)		24-17															
Water In (°C)-Out (°C)		6-11				6-13				7-12				9-14			
Air flow	Total capacity (kW)	Sensible (kW)	Water Flow (ℓ/min)	ΔP (kPa)	Total capacity	Sensible	Water Flow	ΔP	Total capacity	Sensible	Water Flow	ΔP	Total capacity	Sensible	Water Flow	ΔP	
H	6.64	5.12	19.0	31.0	5.33	4.57	10.9	11.9	5.94	4.83	17.0	25.5	4.71	4.24	13.5	17.1	
M	5.95	4.52	17.0	25.6	4.77	4.03	9.8	9.9	5.32	4.27	15.2	21.1	4.22	3.75	12.1	14.2	
L	4.85	3.64	13.9	18.0	3.89	3.22	8.0	7.0	4.34	3.43	12.4	14.8	3.44	3.02	9.9	10.0	
Air temperature (DB°C - WB°C)		25-18.7															
Water In (°C)-Out (°C)		6-11				6-13				7-12				9-14			
Air flow	Total capacity	Sensible	Water Flow	ΔP	Total capacity	Sensible	Water Flow	ΔP	Total capacity	Sensible	Water Flow	ΔP	Total capacity	Sensible	Water Flow	ΔP	
H	8.24	5.28	23.6	45.5	6.58	4.70	13.5	17.0	7.23	4.96	20.7	36.1	5.60	4.34	16.0	23.0	
M	7.38	4.62	21.1	37.4	5.89	4.12	12.1	14.1	6.48	4.34	18.6	29.7	5.01	3.81	14.4	19.0	
L	6.02	3.74	17.2	26.1	4.80	3.30	9.8	10.0	5.28	3.52	15.1	20.9	4.09	3.05	11.7	13.4	
Air temperature (DB°C - WB°C)		27-19.5															
Water In (°C)-Out (°C)		6-11				6-13				7-12				9-14			
Air flow	Total capacity	Sensible	Water Flow	ΔP	Total capacity	Sensible	Water Flow	ΔP	Total capacity	Sensible	Water Flow	ΔP	Total capacity	Sensible	Water Flow	ΔP	
H	9.23	6.01	26.4	55.8	7.29	5.30	14.9	20.3	7.80	5.51	22.5	41.8	6.50	5.08	18.6	29.9	
M	8.26	5.28	23.7	45.8	6.53	4.66	13.4	16.8	6.99	4.84	20.0	34.0	5.82	4.48	16.7	24.7	
L	6.74	4.24	19.3	31.9	5.32	3.75	10.9	11.9	5.70	3.89	16.3	23.8	4.75	3.60	13.6	17.3	
Air temperature (DB°C - WB°C)		27-21															
Water In (°C)-Out (°C)		6-11				6-13				7-12				9-14			
Air flow	Total capacity	Sensible	Water Flow	ΔP	Total capacity	Sensible	Water Flow	ΔP	Total capacity	Sensible	Water Flow	ΔP	Total capacity	Sensible	Water Flow	ΔP	
H	11.02	5.96	31.6	77.0	8.90	5.19	18.2	28.8	9.79	5.58	28.1	62.1	8.02	4.94	23.0	43.4	
M	9.87	5.29	28.3	63.0	7.97	4.61	16.3	23.7	8.77	4.92	25.1	50.9	7.19	4.39	20.6	35.7	
L	8.05	4.26	23.1	43.7	6.50	3.72	13.3	16.7	7.15	3.89	20.5	35.4	5.86	3.55	16.8	25.0	

※ Appendix : Capacity Table

4 Way Cassette

Cooling

※ Total Capacity (kW) / Sensible Capacity (kW) / Water Flow (ℓ/min) / ΔP (kPa)

AG090MN4DKH/EU																	
Air temperature (DB°C - WB°C)		24-17															
Water In (°C)-Out (°C)		6-11				6-13				7-12				9-14			
Air flow		Total capacity	Sensible	Water Flow	ΔP	Total capacity	Sensible	Water Flow	ΔP	Total capacity	Sensible	Water Flow	ΔP	Total capacity	Sensible	Water Flow	ΔP
H		8.10	6.28	23.2	38.3	6.47	5.58	13.2	14.6	7.22	5.92	20.7	31.4	5.69	5.15	16.3	20.9
M		7.60	5.81	21.8	34.4	6.07	5.16	12.4	13.2	6.78	5.48	19.4	28.2	5.35	4.78	15.3	18.8
L		7.12	5.39	20.4	30.7	5.69	4.74	11.6	11.8	6.35	5.06	18.2	25.2	5.01	4.42	14.4	16.8
Air temperature (DB°C - WB°C)		25-18.7															
Water In (°C)-Out (°C)		6-11				6-13				7-12				9-14			
Air flow		Total capacity	Sensible	Water Flow	ΔP	Total capacity	Sensible	Water Flow	ΔP	Total capacity	Sensible	Water Flow	ΔP	Total capacity	Sensible	Water Flow	ΔP
H		10.09	6.51	28.9	56.4	8.02	5.77	16.4	21.1	8.84	6.10	25.3	44.7	6.80	5.30	19.5	28.3
M		9.47	5.97	27.2	50.5	7.53	5.31	15.4	19.0	8.30	5.60	23.8	40.0	6.39	4.88	18.3	25.4
L		8.87	5.56	25.4	45.0	7.05	4.87	14.4	17.0	7.77	5.22	22.3	35.7	5.98	4.49	17.1	22.7
Air temperature (DB°C - WB°C)		27-19.5															
Water In (°C)-Out (°C)		6-11				6-13				7-12				9-14			
Air flow		Total capacity	Sensible	Water Flow	ΔP	Total capacity	Sensible	Water Flow	ΔP	Total capacity	Sensible	Water Flow	ΔP	Total capacity	Sensible	Water Flow	ΔP
H		11.32	7.43	32.5	69.1	8.90	6.52	18.2	25.3	9.72	6.91	28.5	54.9	7.93	6.23	22.7	36.9
M		10.63	6.84	30.5	61.8	8.36	6.01	17.1	22.7	9.13	6.37	26.2	47.3	7.44	5.76	21.3	33.1
L		9.96	6.31	28.5	55.1	7.83	5.55	16.0	20.3	8.55	5.88	24.5	42.2	6.97	5.32	20.0	29.6
Air temperature (DB°C - WB°C)		27-21															
Water In (°C)-Out (°C)		6-11				6-13				7-12				9-14			
Air flow		Total capacity	Sensible	Water Flow	ΔP	Total capacity	Sensible	Water Flow	ΔP	Total capacity	Sensible	Water Flow	ΔP	Total capacity	Sensible	Water Flow	ΔP
H		13.56	7.40	38.9	95.5	10.91	6.42	22.3	35.9	12.03	6.92	34.5	77.0	9.82	6.10	28.2	53.8
M		12.74	6.88	36.5	85.3	10.25	5.97	21.0	32.2	11.30	6.40	32.4	68.9	9.23	5.69	26.4	48.1
L		11.93	6.38	34.2	75.9	9.60	5.54	19.6	28.8	10.58	5.81	30.3	61.3	8.64	5.27	24.8	42.9

AG105MN4DKH/EU																	
Air temperature (DB°C - WB°C)		24-17															
Water In (°C)-Out (°C)		6-11				6-13				7-12				9-14			
Air flow		Total capacity (kW)	Sensible (kW)	Water Flow (ℓ/min)	ΔP (kPa)	Total capacity	Sensible	Water Flow	ΔP	Total capacity	Sensible	Water Flow	ΔP	Total capacity	Sensible	Water Flow	ΔP
H		8.65	6.80	24.8	43.0	6.84	5.97	14.0	16.1	7.68	6.37	22.0	35.0	5.98	5.47	17.1	22.7
M		7.85	6.08	22.5	36.3	6.21	5.33	12.7	13.7	6.97	5.70	20.0	29.6	5.43	4.90	15.6	19.3
L		6.36	4.88	18.2	25.3	5.03	4.24	10.3	9.5	5.65	4.56	16.2	20.6	4.40	3.92	12.6	13.5
Air temperature (DB°C - WB°C)		25-18.7															
Water In (°C)-Out (°C)		6-11				6-13				7-12				9-14			
Air flow		Total capacity	Sensible	Water Flow	ΔP	Total capacity	Sensible	Water Flow	ΔP	Total capacity	Sensible	Water Flow	ΔP	Total capacity	Sensible	Water Flow	ΔP
H		10.86	7.12	31.1	64.2	8.57	6.25	17.5	23.6	9.47	6.63	27.2	50.4	7.21	5.69	20.7	31.4
M		9.86	6.32	28.3	54.1	7.77	5.56	15.9	20.0	8.60	5.89	24.6	42.6	6.54	5.07	18.7	26.5
L		7.99	5.09	22.9	37.5	6.30	4.41	12.9	14.0	6.97	4.75	20.0	29.6	5.30	4.03	15.2	18.5
Air temperature (DB°C - WB°C)		27-19.5															
Water In (°C)-Out (°C)		6-11				6-13				7-12				9-14			
Air flow		Total capacity	Sensible	Water Flow	ΔP	Total capacity	Sensible	Water Flow	ΔP	Total capacity	Sensible	Water Flow	ΔP	Total capacity	Sensible	Water Flow	ΔP
H		12.24	8.15	35.1	79.4	9.55	7.08	19.5	28.5	10.80	7.79	31.0	63.6	8.46	6.74	24.3	41.4
M		11.10	7.25	31.8	66.8	8.66	6.31	17.7	24.1	9.80	6.94	28.1	53.5	7.68	6.02	22.0	35.0
L		9.00	5.79	25.8	46.1	7.02	5.05	14.4	16.8	7.94	5.54	22.8	37.1	6.22	4.81	17.8	24.3
Air temperature (DB°C - WB°C)		27-21															
Water In (°C)-Out (°C)		6-11				6-13				7-12				9-14			
Air flow		Total capacity	Sensible	Water Flow	ΔP	Total capacity	Sensible	Water Flow	ΔP	Total capacity	Sensible	Water Flow	ΔP	Total capacity	Sensible	Water Flow	ΔP
H		14.72	8.18	42.2	110.7	11.78	7.04	24.1	41.0	13.02	7.62	37.3	88.7	10.57	6.67	30.3	61.2
M		13.36	7.35	38.3	92.9	10.69	6.34	21.9	34.6	11.82	6.81	33.9	74.6	9.59	6.01	27.5	51.5
L		10.83	5.89	31.0	63.8	8.66	5.08	17.7	24.1	9.58	5.35	27.4	51.4	7.77	4.82	22.3	35.7

※ Appendix : Capacity Table

4 Way Cassette

Heating

※ Capacity (kW) / Water Flow (ℓ/min) / ΔP (kPa)

AG060MN4DKH/EU															
Air temperature(°C)	18														
Water In(°C)-Out(°C)	45-40			50-45			55-50			55-45			60-50		
Air Flow	Capacity	Water Flow	ΔP	Capacity	Water Flow	ΔP	Capacity	Water Flow	ΔP	Capacity	Water Flow	ΔP	Capacity	Water Flow	ΔP
H	7.80	22.4	41.3	8.89	25.5	52.4	10.30	29.6	68.3	9.43	13.5	16.7	11.86	17.0	25.5
M	7.09	20.3	34.9	8.09	23.2	44.3	9.50	27.3	59.2	8.69	12.5	14.5	10.78	15.5	21.6
L	6.19	17.8	27.5	7.33	21.0	37.3	8.67	24.9	50.5	7.94	11.4	12.4	9.42	13.5	17.1
Air temperature(°C)	20														
Water In(°C)-Out(°C)	45-40			50-45			55-50			55-45			60-50		
Air Flow	Capacity	Water Flow	ΔP	Capacity	Water Flow	ΔP	Capacity	Water Flow	ΔP	Capacity	Water Flow	ΔP	Capacity	Water Flow	ΔP
H	7.30	21.1	37.3	8.32	23.9	46.6	9.64	27.7	60.7	8.82	12.7	14.9	11.20	16.1	23.1
M	6.64	19.0	31.0	7.57	21.7	39.4	8.89	25.5	52.7	8.14	11.7	12.9	10.18	14.6	19.6
L	5.80	16.6	24.5	6.86	19.7	33.2	8.11	23.3	44.9	7.42	10.6	11.0	8.90	12.7	15.5
Air temperature(°C)	22														
Water In(°C)-Out(°C)	45-40			50-45			55-50			55-45			60-50		
Air Flow	Capacity	Water Flow	ΔP	Capacity	Water Flow	ΔP	Capacity	Water Flow	ΔP	Capacity	Water Flow	ΔP	Capacity	Water Flow	ΔP
H	6.41	18.4	29.2	7.31	21.0	37.1	8.46	24.3	48.2	7.74	11.1	11.8	10.50	15.0	20.6
M	5.83	16.7	24.7	6.64	19.1	31.3	7.81	22.4	42.0	7.15	10.3	10.3	9.55	13.7	17.5
L	5.09	14.6	19.6	6.02	17.3	26.5	7.12	20.4	35.9	6.52	9.4	8.8	8.34	11.9	13.9

AG072MN4DKH/EU															
Air temperature(°C)	18														
Water In(°C)-Out(°C)	45-40			50-45			55-50			55-45			60-50		
Air Flow	Capacity	Water Flow	ΔP	Capacity	Water Flow	ΔP	Capacity	Water Flow	ΔP	Capacity	Water Flow	ΔP	Capacity	Water Flow	ΔP
H	9.08	26.0	54.2	10.35	29.7	68.7	11.99	34.4	89.6	10.97	15.7	21.9	12.89	18.5	29.5
M	8.14	23.3	44.5	9.27	26.6	56.4	10.90	31.3	75.5	9.98	14.3	18.5	11.55	16.5	24.3
L	6.63	19.0	31.0	8.54	24.5	49.0	10.17	29.2	67.1	8.71	12.5	14.6	9.42	13.5	17.1
Air temperature(°C)	20														
Water In(°C)-Out(°C)	45-40			50-45			55-50			55-45			60-50		
Air Flow	Capacity	Water Flow	ΔP	Capacity	Water Flow	ΔP	Capacity	Water Flow	ΔP	Capacity	Water Flow	ΔP	Capacity	Water Flow	ΔP
H	8.50	24.5	48.6	9.69	27.8	61.1	11.22	32.2	79.5	10.27	14.7	19.5	12.17	17.4	26.7
M	7.61	21.8	39.6	8.68	24.9	50.2	10.20	29.3	67.1	9.34	13.4	16.5	10.90	15.6	22.0
L	6.21	17.8	27.6	7.99	22.9	43.6	9.52	27.3	59.7	8.06	11.6	12.7	8.89	12.7	15.5
Air temperature(°C)	22														
Water In(°C)-Out(°C)	45-40			50-45			55-50			55-45			60-50		
Air Flow	Capacity	Water Flow	ΔP	Capacity	Water Flow	ΔP	Capacity	Water Flow	ΔP	Capacity	Water Flow	ΔP	Capacity	Water Flow	ΔP
H	7.46	21.4	38.2	8.51	24.4	48.5	9.85	28.3	63.1	9.02	12.9	15.5	11.41	16.4	23.8
M	6.68	19.2	31.4	7.62	21.9	39.9	8.96	25.7	53.4	8.20	11.8	13.1	10.22	14.6	19.7
L	5.45	15.6	22.0	7.02	20.1	34.8	8.36	24.0	47.6	7.46	10.7	11.1	8.34	11.9	13.9

※ Appendix : Capacity Table

4 Way Cassette

Heating

※ Capacity (kW) / Water Flow (ℓ/min) / ΔP (kPa)

AG090MN4DKH/EU															
Air temperature(°C)	18														
Water In(°C)-Out(°C)	45-40			50-45			55-50			55-45			60-50		
Air Flow	Capacity	Water Flow	ΔP	Capacity	Water Flow	ΔP	Capacity	Water Flow	ΔP	Capacity	Water Flow	ΔP	Capacity	Water Flow	ΔP
H	10.68	30.6	62.4	12.18	35.0	79.1	14.10	40.5	103.0	12.91	18.5	25.2	15.47	22.2	35.4
M	10.03	28.8	55.8	11.44	32.8	70.8	13.45	38.6	94.8	12.31	17.7	23.2	14.52	20.8	31.8
L	9.40	26.9	49.7	10.71	30.7	63.1	12.59	36.1	84.4	11.52	16.5	20.7	13.61	19.5	28.4
Air temperature(°C)	20														
Water In(°C)-Out(°C)	45-40			50-45			55-50			55-45			60-50		
Air Flow	Capacity	Water Flow	ΔP	Capacity	Water Flow	ΔP	Capacity	Water Flow	ΔP	Capacity	Water Flow	ΔP	Capacity	Water Flow	ΔP
H	10.00	28.9	56.3	11.40	32.7	70.4	13.20	37.9	91.6	12.08	17.3	22.4	14.61	20.9	32.1
M	9.39	26.9	49.7	10.71	30.7	63.1	12.58	36.1	84.3	11.51	16.5	20.6	13.72	19.7	28.8
L	8.80	25.2	44.3	10.03	28.8	56.2	11.79	33.8	75.2	10.79	15.5	18.4	12.85	18.4	25.7
Air temperature(°C)	22														
Water In(°C)-Out(°C)	45-40			50-45			55-50			55-45			60-50		
Air Flow	Capacity	Water Flow	ΔP	Capacity	Water Flow	ΔP	Capacity	Water Flow	ΔP	Capacity	Water Flow	ΔP	Capacity	Water Flow	ΔP
H	8.78	25.2	44.1	10.01	28.7	56.0	11.59	33.3	73.0	10.61	15.2	17.9	13.69	19.6	28.7
M	8.24	23.6	39.6	9.40	27.0	50.2	11.05	31.7	67.2	10.11	14.5	16.4	12.86	18.4	25.8
L	7.72	22.1	35.3	8.80	25.3	44.8	10.35	29.7	60.0	9.47	13.6	14.7	12.05	17.3	23.0

AG105MN4DKH/EU															
Air temperature(°C)	18														
Water In(°C)-Out(°C)	45-40			50-45			55-50			55-45			60-50		
Air Flow	Capacity	Water Flow	ΔP	Capacity	Water Flow	ΔP	Capacity	Water Flow	ΔP	Capacity	Water Flow	ΔP	Capacity	Water Flow	ΔP
H	11.43	32.8	70.3	13.03	37.4	89.2	15.09	43.3	116.2	13.81	19.8	28.4	18.56	26.6	48.7
M	10.37	29.7	59.2	11.83	34.0	75.2	13.90	39.9	100.5	12.72	18.3	24.6	16.84	24.1	41.1
L	8.41	24.1	40.9	10.75	30.9	63.9	12.81	36.8	87.6	11.72	16.8	21.4	13.65	19.6	28.5
Air temperature(°C)	20														
Water In(°C)-Out(°C)	45-40			50-45			55-50			55-45			60-50		
Air Flow	Capacity	Water Flow	ΔP	Capacity	Water Flow	ΔP	Capacity	Water Flow	ΔP	Capacity	Water Flow	ΔP	Capacity	Water Flow	ΔP
H	10.70	30.9	63.4	12.20	35.0	79.3	14.12	40.5	103.2	12.92	18.5	25.3	17.53	25.1	44.0
M	9.71	27.8	52.7	11.07	31.8	66.9	13.01	37.3	89.4	11.91	17.1	21.9	15.91	22.8	37.2
L	7.87	22.6	36.5	10.06	28.9	56.9	11.99	34.4	78.1	10.97	15.7	19.1	12.89	18.5	25.9
Air temperature(°C)	22														
Water In(°C)-Out(°C)	45-40			50-45			55-50			55-45			60-50		
Air Flow	Capacity	Water Flow	ΔP	Capacity	Water Flow	ΔP	Capacity	Water Flow	ΔP	Capacity	Water Flow	ΔP	Capacity	Water Flow	ΔP
H	9.39	26.9	49.7	10.71	30.7	63.1	12.40	35.6	82.1	11.35	16.3	20.1	16.43	23.5	39.3
M	8.52	24.4	41.9	9.72	27.9	53.2	11.42	32.8	71.2	10.45	15.0	17.4	14.91	21.4	33.2
L	6.91	19.8	29.1	8.83	25.3	45.4	10.52	30.2	62.3	9.63	13.8	15.2	12.08	17.3	23.1

※ Appendix : Capacity Table

360 Cassette

Cooling

※ Total Capacity (kW) / Sensible Capacity (kW) / Water Flow (ℓ/min) / ΔP (kPa)

AG060MN4PKH/EU																	
Air temperature (DB°C - WB°C)		24-17															
Water In (°C)-Out (°C)		6-11				6-13				7-12				9-14			
Air flow	Total capacity	Sensible	Water Flow	ΔP	Total capacity	Sensible	Water Flow	ΔP	Total capacity	Sensible	Water Flow	ΔP	Total capacity	Sensible	Water Flow	ΔP	
H	5.66	4.50	16.2	23.7	4.57	4.02	9.4	9.2	5.08	4.25	14.5	19.6	4.05	3.74	11.6	13.3	
M	5.15	4.03	14.8	20.1	4.16	3.60	8.5	7.9	4.62	3.81	13.2	16.7	3.69	3.36	10.6	11.3	
L	4.50	3.48	12.9	15.9	3.63	3.09	7.4	6.2	4.03	3.29	11.6	13.2	3.22	2.90	9.2	9.0	
Air temperature (DB°C - WB°C)		25-18.7															
Water In (°C)-Out (°C)		6-11				6-13				7-12				9-14			
Air flow	Total capacity	Sensible	Water Flow	ΔP	Total capacity	Sensible	Water Flow	ΔP	Total capacity	Sensible	Water Flow	ΔP	Total capacity	Sensible	Water Flow	ΔP	
H	6.99	4.64	20.0	34.4	5.61	4.14	11.5	13.1	6.16	4.36	17.6	27.5	4.79	3.82	13.7	17.8	
M	6.36	4.12	18.2	29.1	5.10	3.69	10.4	11.1	5.60	3.88	16.0	23.3	4.36	3.41	12.5	15.1	
L	5.55	3.58	15.9	22.9	4.46	3.16	9.1	8.8	4.89	3.37	14.0	18.4	3.81	2.93	10.9	12.0	
Air temperature (DB°C - WB°C)		27-19.5															
Water In (°C)-Out (°C)		6-11				6-13				7-12				9-14			
Air flow	Total capacity	Sensible	Water Flow	ΔP	Total capacity	Sensible	Water Flow	ΔP	Total capacity	Sensible	Water Flow	ΔP	Total capacity	Sensible	Water Flow	ΔP	
H	7.82	5.27	22.4	41.9	6.20	4.65	12.7	15.5	6.50	4.74	19.0	31.3	5.55	4.46	15.9	22.9	
M	7.11	4.70	20.4	35.4	5.64	4.16	11.5	13.2	5.91	4.23	16.9	25.6	5.04	3.99	14.5	19.4	
L	6.21	4.05	17.8	27.9	4.93	3.58	10.1	10.5	5.16	3.64	14.8	20.2	4.41	3.44	12.6	15.4	
Air temperature (DB°C - WB°C)		27-21															
Water In (°C)-Out (°C)		6-11				6-13				7-12				9-14			
Air flow	Total capacity	Sensible	Water Flow	ΔP	Total capacity	Sensible	Water Flow	ΔP	Total capacity	Sensible	Water Flow	ΔP	Total capacity	Sensible	Water Flow	ΔP	
H	9.32	5.25	26.7	57.3	7.54	4.57	15.4	21.8	8.29	4.92	23.8	46.5	6.82	4.36	19.5	32.8	
M	8.47	4.73	24.3	48.3	6.86	4.12	14.0	18.5	7.54	4.40	21.6	39.3	6.20	3.93	17.8	27.8	
L	7.40	4.09	21.2	38.0	5.99	3.57	12.3	14.6	6.59	3.74	18.9	30.9	5.41	3.40	15.5	21.9	

AG072MN4PKH/EU																	
Air temperature (DB°C - WB°C)		24-17															
Water In (°C)-Out (°C)		6-11				6-13				7-12				9-14			
Air flow	Total capacity (kW)	Sensible (kW)	Water Flow (ℓ/min)	ΔP (kPa)	Total capacity	Sensible	Water Flow	ΔP	Total capacity	Sensible	Water Flow	ΔP	Total capacity	Sensible	Water Flow	ΔP	
H	6.64	5.12	19.0	23.1	5.33	4.57	10.9	8.9	5.94	4.83	17.0	19.1	4.71	4.24	13.5	12.9	
M	5.95	4.52	17.0	19.1	4.77	4.03	9.8	7.3	5.32	4.27	15.2	15.8	4.22	3.75	12.1	10.6	
L	4.85	3.64	13.9	13.5	3.89	3.22	8.0	5.0	4.34	3.43	12.4	11.2	3.44	3.02	9.9	7.4	
Air temperature (DB°C - WB°C)		25-18.7															
Water In (°C)-Out (°C)		6-11				6-13				7-12				9-14			
Air flow	Total capacity	Sensible	Water Flow	ΔP	Total capacity	Sensible	Water Flow	ΔP	Total capacity	Sensible	Water Flow	ΔP	Total capacity	Sensible	Water Flow	ΔP	
H	8.24	5.28	23.6	33.4	6.58	4.70	13.5	12.8	7.23	4.96	20.7	26.7	5.60	4.34	16.0	17.3	
M	7.38	4.62	21.1	27.6	5.89	4.12	12.1	10.6	6.48	4.34	18.6	22.1	5.01	3.81	14.4	14.3	
L	6.02	3.74	17.2	19.5	4.80	3.30	9.8	7.4	5.28	3.52	15.1	15.6	4.09	3.05	11.7	10.1	
Air temperature (DB°C - WB°C)		27-19.5															
Water In (°C)-Out (°C)		6-11				6-13				7-12				9-14			
Air flow	Total capacity	Sensible	Water Flow	ΔP	Total capacity	Sensible	Water Flow	ΔP	Total capacity	Sensible	Water Flow	ΔP	Total capacity	Sensible	Water Flow	ΔP	
H	9.23	6.01	26.4	40.6	7.29	5.30	14.9	15.2	7.80	5.51	22.5	30.7	6.50	5.08	18.6	22.3	
M	8.26	5.28	23.7	33.6	6.53	4.66	13.4	12.6	6.99	4.84	20.0	25.2	5.82	4.48	16.7	18.5	
L	6.74	4.24	19.3	23.7	5.32	3.75	10.9	8.9	5.70	3.89	16.3	17.8	4.75	3.60	13.6	13.0	
Air temperature (DB°C - WB°C)		27-21															
Water In (°C)-Out (°C)		6-11				6-13				7-12				9-14			
Air flow	Total capacity	Sensible	Water Flow	ΔP	Total capacity	Sensible	Water Flow	ΔP	Total capacity	Sensible	Water Flow	ΔP	Total capacity	Sensible	Water Flow	ΔP	
H	11.02	5.96	31.6	55.3	8.90	5.19	18.2	21.4	9.79	5.58	28.1	45.0	8.02	4.94	23.0	31.9	
M	9.87	5.29	28.3	45.7	7.97	4.61	16.3	17.8	8.77	4.92	25.1	37.2	7.19	4.39	20.6	26.4	
L	8.05	4.26	23.1	32.1	6.50	3.72	13.3	12.5	7.15	3.89	20.5	26.2	5.86	3.55	16.8	18.7	

※ Appendix : Capacity Table

360 Cassette

Cooling

※ Total Capacity (kW) / Sensible Capacity (kW) / Water Flow (ℓ/min) / ΔP (kPa)

AG090MN4PKH/EU																	
Air temperature (DB°C - WB°C)		24-17															
Water In (°C)-Out (°C)		6-11				6-13				7-12				9-14			
Air flow		Total capacity	Sensible	Water Flow	ΔP	Total capacity	Sensible	Water Flow	ΔP	Total capacity	Sensible	Water Flow	ΔP	Total capacity	Sensible	Water Flow	ΔP
H		8.10	6.28	23.2	32.4	6.47	5.58	13.2	12.4	7.22	5.92	20.7	26.7	5.69	5.15	16.3	17.8
M		7.60	5.81	21.8	29.1	6.07	5.16	12.4	11.2	6.78	5.48	19.4	23.9	5.35	4.78	15.3	16.0
L		7.12	5.39	20.4	26.0	5.69	4.74	11.6	10.0	6.35	5.06	18.2	21.4	5.01	4.42	14.4	14.3
Air temperature (DB°C - WB°C)		25-18.7															
Water In (°C)-Out (°C)		6-11				6-13				7-12				9-14			
Air flow		Total capacity	Sensible	Water Flow	ΔP	Total capacity	Sensible	Water Flow	ΔP	Total capacity	Sensible	Water Flow	ΔP	Total capacity	Sensible	Water Flow	ΔP
H		10.09	6.51	28.9	47.4	8.02	5.77	16.4	18.0	8.84	6.10	25.3	37.7	6.80	5.30	19.5	24.0
M		9.47	5.97	27.2	42.5	7.53	5.31	15.4	16.1	8.30	5.60	23.8	33.8	6.39	4.88	18.3	21.6
L		8.87	5.56	25.4	38.0	7.05	4.87	14.4	14.4	7.77	5.22	22.3	30.2	5.98	4.49	17.1	19.3
Air temperature (DB°C - WB°C)		27-19.5															
Water In (°C)-Out (°C)		6-11				6-13				7-12				9-14			
Air flow		Total capacity	Sensible	Water Flow	ΔP	Total capacity	Sensible	Water Flow	ΔP	Total capacity	Sensible	Water Flow	ΔP	Total capacity	Sensible	Water Flow	ΔP
H		11.32	7.43	32.5	58.0	8.90	6.52	18.2	21.5	9.72	6.91	28.5	46.2	7.93	6.23	22.7	31.3
M		10.63	6.84	30.5	52.0	8.36	6.01	17.1	19.3	9.13	6.37	26.2	39.9	7.44	5.76	21.3	28.1
L		9.96	6.31	28.5	46.4	7.83	5.55	16.0	17.3	8.55	5.88	24.5	35.6	6.97	5.32	20.0	25.1
Air temperature (DB°C - WB°C)		27-21															
Water In (°C)-Out (°C)		6-11				6-13				7-12				9-14			
Air flow		Total capacity	Sensible	Water Flow	ΔP	Total capacity	Sensible	Water Flow	ΔP	Total capacity	Sensible	Water Flow	ΔP	Total capacity	Sensible	Water Flow	ΔP
H		13.56	7.40	38.9	79.7	10.91	6.42	22.3	30.4	12.03	6.92	34.5	64.5	9.82	6.10	28.2	45.3
M		12.74	6.88	36.5	71.3	10.25	5.97	21.0	27.3	11.30	6.40	32.4	57.8	9.23	5.69	26.4	40.6
L		11.93	6.38	34.2	63.6	9.60	5.54	19.6	24.4	10.58	5.81	30.3	51.5	8.64	5.27	24.8	36.3

AG105MN4PKH/EU																	
Air temperature (DB°C - WB°C)		24-17															
Water In (°C)-Out (°C)		6-11				6-13				7-12				9-14			
Air flow		Total capacity (kW)	Sensible (kW)	Water Flow (ℓ/min)	ΔP (kPa)	Total capacity	Sensible	Water Flow	ΔP	Total capacity	Sensible	Water Flow	ΔP	Total capacity	Sensible	Water Flow	ΔP
H		8.65	6.80	24.8	36.3	6.84	5.97	14.0	13.7	7.68	6.37	22.0	29.6	5.98	5.47	17.1	19.3
M		7.85	6.08	22.5	30.7	6.21	5.33	12.7	11.6	6.97	5.70	20.0	25.1	5.43	4.90	15.6	16.4
L		6.36	4.88	18.2	21.5	5.03	4.24	10.3	8.0	5.65	4.56	16.2	17.5	4.40	3.92	12.6	11.4
Air temperature (DB°C - WB°C)		25-18.7															
Water In (°C)-Out (°C)		6-11				6-13				7-12				9-14			
Air flow		Total capacity	Sensible	Water Flow	ΔP	Total capacity	Sensible	Water Flow	ΔP	Total capacity	Sensible	Water Flow	ΔP	Total capacity	Sensible	Water Flow	ΔP
H		10.86	7.12	31.1	53.9	8.57	6.25	17.5	20.1	9.47	6.63	27.2	42.5	7.21	5.69	20.7	26.6
M		9.86	6.32	28.3	45.5	7.77	5.56	15.9	17.0	8.60	5.89	24.6	35.9	6.54	5.07	18.7	22.5
L		7.99	5.09	22.9	31.7	6.30	4.41	12.9	11.9	6.97	4.75	20.0	25.1	5.30	4.03	15.2	15.7
Air temperature (DB°C - WB°C)		27-19.5															
Water In (°C)-Out (°C)		6-11				6-13				7-12				9-14			
Air flow		Total capacity	Sensible	Water Flow	ΔP	Total capacity	Sensible	Water Flow	ΔP	Total capacity	Sensible	Water Flow	ΔP	Total capacity	Sensible	Water Flow	ΔP
H		12.24	8.15	35.1	66.4	9.55	7.08	19.5	24.2	10.80	7.79	31.0	53.4	8.46	6.74	24.3	35.0
M		11.10	7.25	31.8	56.0	8.66	6.31	17.7	20.5	9.80	6.94	28.1	45.1	7.68	6.02	22.0	29.6
L		9.00	5.79	25.8	38.9	7.02	5.05	14.4	14.3	7.94	5.54	22.8	31.4	6.22	4.81	17.8	20.7
Air temperature (DB°C - WB°C)		27-21															
Water In (°C)-Out (°C)		6-11				6-13				7-12				9-14			
Air flow		Total capacity	Sensible	Water Flow	ΔP	Total capacity	Sensible	Water Flow	ΔP	Total capacity	Sensible	Water Flow	ΔP	Total capacity	Sensible	Water Flow	ΔP
H		14.72	8.18	42.2	92.2	11.78	7.04	24.1	34.6	13.02	7.62	37.3	74.2	10.57	6.67	30.3	51.4
M		13.36	7.35	38.3	77.6	10.69	6.34	21.9	29.3	11.82	6.81	33.9	62.5	9.59	6.01	27.5	43.4
L		10.83	5.89	31.0	53.6	8.66	5.08	17.7	20.5	9.58	5.35	27.4	43.3	7.77	4.82	22.3	30.2

※ Appendix : Capacity Table

360 Cassette

Heating

※ Capacity (kW) / Water Flow (ℓ/min) / ΔP (kPa)

AG060MN4PKH/EU															
Air temperature(°C)	18														
Water In(°C)-Out(°C)	45-40			50-45			55-50			55-45			60-50		
Air Flow	Capacity	Water Flow	ΔP	Capacity	Water Flow	ΔP	Capacity	Water Flow	ΔP	Capacity	Water Flow	ΔP	Capacity	Water Flow	ΔP
H	7.80	22.4	41.7	8.89	25.5	52.9	10.30	29.6	68.9	9.43	13.5	16.9	11.86	17.0	25.7
M	7.09	20.3	35.2	8.09	23.2	44.7	9.50	27.3	59.7	8.69	12.5	14.6	10.78	15.5	21.8
L	6.19	17.8	27.8	7.33	21.0	37.7	8.67	24.9	50.9	7.94	11.4	12.5	9.42	13.5	17.2
Air temperature(°C)	20														
Water In(°C)-Out(°C)	45-40			50-45			55-50			55-45			60-50		
Air Flow	Capacity	Water Flow	ΔP	Capacity	Water Flow	ΔP	Capacity	Water Flow	ΔP	Capacity	Water Flow	ΔP	Capacity	Water Flow	ΔP
H	7.30	21.1	37.6	8.32	23.9	47.0	9.64	27.7	61.3	8.82	12.7	15.0	11.20	16.1	23.3
M	6.64	19.0	31.3	7.57	21.7	39.8	8.89	25.5	53.1	8.14	11.7	13.0	10.18	14.6	19.7
L	5.80	16.6	24.7	6.86	19.7	33.5	8.11	23.3	45.3	7.42	10.6	11.1	8.90	12.7	15.6
Air temperature(°C)	22														
Water In(°C)-Out(°C)	45-40			50-45			55-50			55-45			60-50		
Air Flow	Capacity	Water Flow	ΔP	Capacity	Water Flow	ΔP	Capacity	Water Flow	ΔP	Capacity	Water Flow	ΔP	Capacity	Water Flow	ΔP
H	6.41	18.4	29.5	7.31	21.0	37.4	8.46	24.3	48.7	7.74	11.1	11.9	10.50	15.0	20.8
M	5.83	16.7	24.9	6.64	19.1	31.6	7.81	22.4	42.3	7.15	10.3	10.4	9.55	13.7	17.6
L	5.09	14.6	19.7	6.02	17.3	26.7	7.12	20.4	36.2	6.52	9.4	8.9	8.34	11.9	14.0

AG072MN4PKH/EU															
Air temperature(°C)	18														
Water In(°C)-Out(°C)	45-40			50-45			55-50			55-45			60-50		
Air Flow	Capacity	Water Flow	ΔP	Capacity	Water Flow	ΔP	Capacity	Water Flow	ΔP	Capacity	Water Flow	ΔP	Capacity	Water Flow	ΔP
H	9.08	26.0	39.5	10.35	29.7	50.1	11.99	34.4	65.3	10.97	15.7	16.0	12.89	18.5	21.9
M	8.14	23.3	32.7	9.27	26.6	41.4	10.90	31.3	55.5	9.98	14.3	13.6	11.55	16.5	18.2
L	6.63	19.0	23.1	8.54	24.5	36.4	10.17	29.2	49.9	8.71	12.5	10.8	9.42	13.5	12.8
Air temperature(°C)	20														
Water In(°C)-Out(°C)	45-40			50-45			55-50			55-45			60-50		
Air Flow	Capacity	Water Flow	ΔP	Capacity	Water Flow	ΔP	Capacity	Water Flow	ΔP	Capacity	Water Flow	ΔP	Capacity	Water Flow	ΔP
H	8.50	24.5	35.6	9.69	27.8	44.7	11.22	32.2	58.2	10.27	14.7	14.3	12.17	17.4	19.9
M	7.61	21.8	29.2	8.68	24.9	37.0	10.20	29.3	49.5	9.34	13.4	12.1	10.90	15.6	16.5
L	6.21	17.8	20.6	7.99	22.9	32.5	9.52	27.3	44.6	8.06	11.6	9.5	8.89	12.7	11.6
Air temperature(°C)	22														
Water In(°C)-Out(°C)	45-40			50-45			55-50			55-45			60-50		
Air Flow	Capacity	Water Flow	ΔP	Capacity	Water Flow	ΔP	Capacity	Water Flow	ΔP	Capacity	Water Flow	ΔP	Capacity	Water Flow	ΔP
H	7.46	21.4	28.2	8.51	24.4	35.8	9.85	28.3	46.6	9.02	12.9	11.4	11.41	16.4	17.8
M	6.68	19.2	23.4	7.62	21.9	29.6	8.96	25.7	39.7	8.20	11.8	9.7	10.22	14.6	14.8
L	5.45	15.6	16.5	7.02	20.1	26.1	8.36	24.0	35.7	7.46	10.7	8.4	8.34	11.9	10.4

※ Appendix : Capacity Table

360 Cassette

Heating

※ Capacity (kW) / Water Flow (ℓ/min) / ΔP (kPa)

AG090MN4PKH/EU															
Air temperature(°C)	18														
Water In(°C)-Out(°C)	45-40			50-45			55-50			55-45			60-50		
Air Flow	Capacity	Water Flow	ΔP	Capacity	Water Flow	ΔP	Capacity	Water Flow	ΔP	Capacity	Water Flow	ΔP	Capacity	Water Flow	ΔP
H	10.68	30.6	52.4	12.18	35.0	66.5	14.10	40.5	86.5	12.91	18.5	21.2	15.47	22.2	30.0
M	10.03	28.8	47.0	11.44	32.8	59.6	13.45	38.6	79.8	12.31	17.7	19.5	14.52	20.8	26.9
L	9.40	26.9	41.9	10.71	30.7	53.2	12.59	36.1	71.1	11.52	16.5	17.4	13.61	19.5	24.1
Air temperature(°C)	20														
Water In(°C)-Out(°C)	45-40			50-45			55-50			55-45			60-50		
Air Flow	Capacity	Water Flow	ΔP	Capacity	Water Flow	ΔP	Capacity	Water Flow	ΔP	Capacity	Water Flow	ΔP	Capacity	Water Flow	ΔP
H	10.00	28.9	47.4	11.40	32.7	59.2	13.20	37.9	77.1	12.08	17.3	18.9	14.61	20.9	27.2
M	9.39	26.9	41.9	10.71	30.7	53.2	12.58	36.1	71.0	11.51	16.5	17.4	13.72	19.7	24.4
L	8.80	25.2	37.4	10.03	28.8	47.5	11.79	33.8	63.5	10.79	15.5	15.5	12.85	18.4	21.8
Air temperature(°C)	22														
Water In(°C)-Out(°C)	45-40			50-45			55-50			55-45			60-50		
Air Flow	Capacity	Water Flow	ΔP	Capacity	Water Flow	ΔP	Capacity	Water Flow	ΔP	Capacity	Water Flow	ΔP	Capacity	Water Flow	ΔP
H	8.78	25.2	37.3	10.01	28.7	47.3	11.59	33.3	61.6	10.61	15.2	15.1	13.69	19.6	24.3
M	8.24	23.6	33.4	9.40	27.0	42.5	11.05	31.7	56.8	10.11	14.5	13.9	12.86	18.4	21.9
L	7.72	22.1	29.9	8.80	25.3	37.9	10.35	29.7	50.8	9.47	13.6	12.4	12.05	17.3	19.6

AG105MN4PKH/EU															
Air temperature(°C)	18														
Water In(°C)-Out(°C)	45-40			50-45			55-50			55-45			60-50		
Air Flow	Capacity	Water Flow	ΔP	Capacity	Water Flow	ΔP	Capacity	Water Flow	ΔP	Capacity	Water Flow	ΔP	Capacity	Water Flow	ΔP
H	11.43	32.8	59.0	13.03	37.4	74.8	15.09	43.3	97.4	13.81	19.8	23.9	18.56	26.6	41.0
M	10.37	29.7	49.8	11.83	34.0	63.2	13.90	39.9	84.5	12.72	18.3	20.7	16.84	24.1	34.7
L	8.41	24.1	34.6	10.75	30.9	54.0	12.81	36.8	74.0	11.72	16.8	18.1	13.65	19.6	24.2
Air temperature(°C)	20														
Water In(°C)-Out(°C)	45-40			50-45			55-50			55-45			60-50		
Air Flow	Capacity	Water Flow	ΔP	Capacity	Water Flow	ΔP	Capacity	Water Flow	ΔP	Capacity	Water Flow	ΔP	Capacity	Water Flow	ΔP
H	10.70	30.9	53.2	12.20	35.0	66.6	14.12	40.5	86.7	12.92	18.5	21.2	17.53	25.1	37.2
M	9.71	27.8	44.4	11.07	31.8	56.3	13.01	37.3	75.3	11.91	17.1	18.4	15.91	22.8	31.4
L	7.87	22.6	30.9	10.06	28.9	48.2	11.99	34.4	66.0	10.97	15.7	16.2	12.89	18.5	22.0
Air temperature(°C)	22														
Water In(°C)-Out(°C)	45-40			50-45			55-50			55-45			60-50		
Air Flow	Capacity	Water Flow	ΔP	Capacity	Water Flow	ΔP	Capacity	Water Flow	ΔP	Capacity	Water Flow	ΔP	Capacity	Water Flow	ΔP
H	9.39	26.9	41.9	10.71	30.7	53.2	12.40	35.6	69.2	11.35	16.3	16.9	16.43	23.5	33.3
M	8.52	24.4	35.4	9.72	27.9	45.0	11.42	32.8	60.1	10.45	15.0	14.7	14.91	21.4	28.2
L	6.91	19.8	24.7	8.83	25.3	38.5	10.52	30.2	52.8	9.63	13.8	12.9	12.08	17.3	19.7

2020.10
Ver.1.6

Samsung Electronics Co., LTD.

Head Office (Suwon Korea) 129, Samsung-Ro, Yeongtong-Gu, Suwon City, Gyeonggi-Do, Korea 16677
Website : www.samsung.com, <https://partnerhub.samsung.com> Email : airconditioner@samsung.com
Images and data in this book may subject to change without prior notice.